

Starter

LET'S

Workbook

GO



R. Nakata

OXFORD

Starter

LET'S
Workbook
GO

by
R. Nakata

OXFORD
UNIVERSITY PRESS

Table of Contents

Lesson 1	A a	page 4
Lesson 2	E e	page 6
Lesson 3	I i	page 8
Lesson 4	O o	page 10
Lesson 5	U u	page 12
Lesson 6	B b	page 14
Lesson 7	C c	page 16
Lesson 8	D d	page 18
Lesson 9	G g	page 20
Lesson 10	P p	page 22
Lesson 11	T t	page 24
Lesson 12	V v	page 26
Lesson 13	Z z	page 28
Lesson 14	F f	page 30
Lesson 15	L l	page 32
Lesson 16	M m	page 34
Lesson 17	N n	page 36
Lesson 18	S s	page 38
Lesson 19	X x	page 40
Lesson 20	J j	page 42
Lesson 21	K k	page 44
Lesson 22	H h	page 46
Lesson 23	Q q	page 48
Lesson 24	R r	page 50
Lesson 25	W w	page 52
Lesson 26	Y y	page 54
Lesson 27	A B C ...	page 56
Lesson 28	a b c ...	page 58
Lesson 29	Good-bye!	page 60

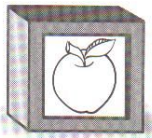

Lesson 1

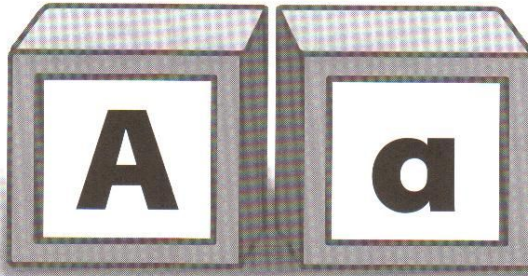

Trace. Write.



Follow. Trace. Color.

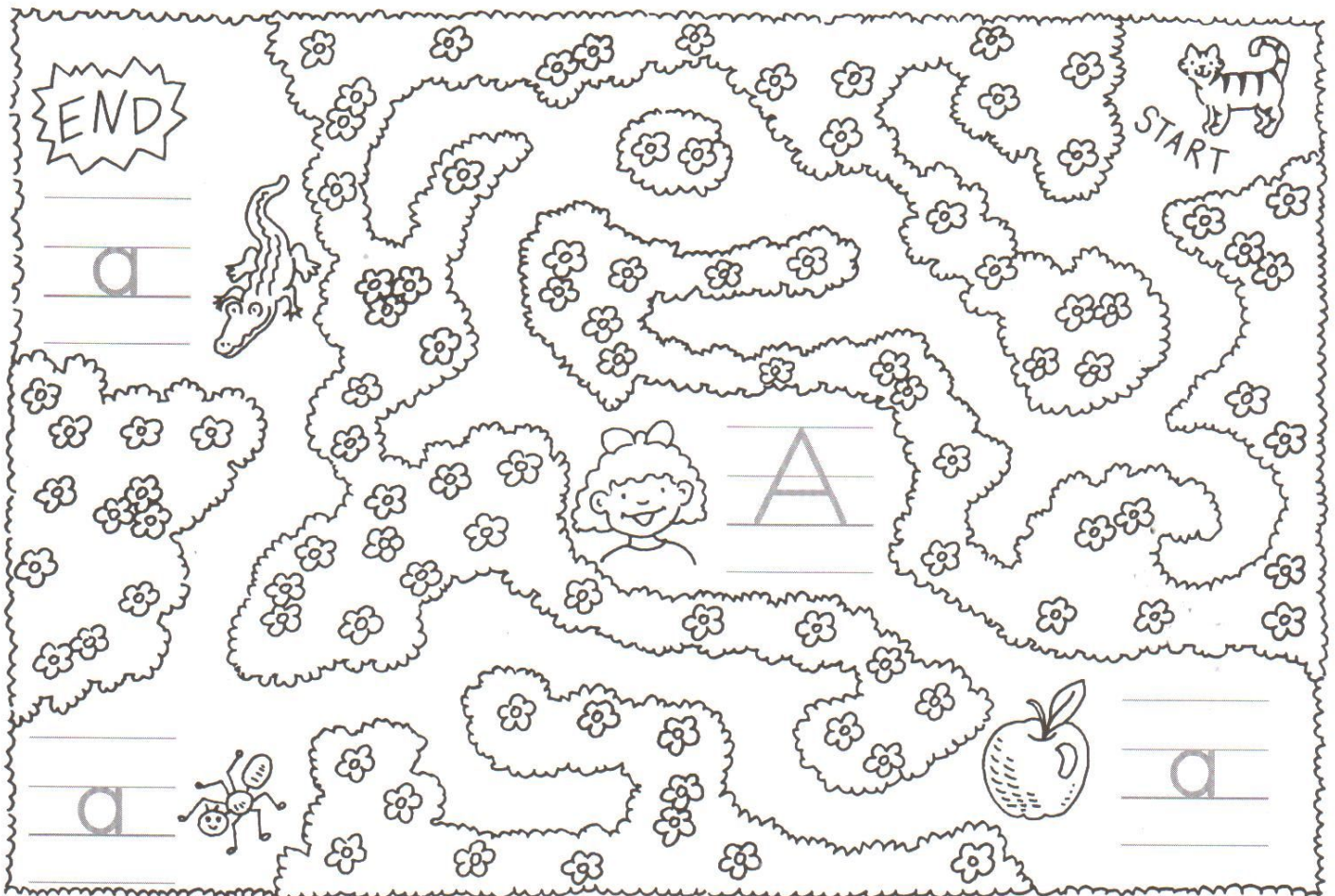

Color.





Lesson 2

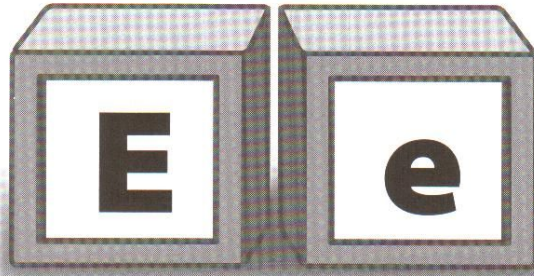

Trace. Write.

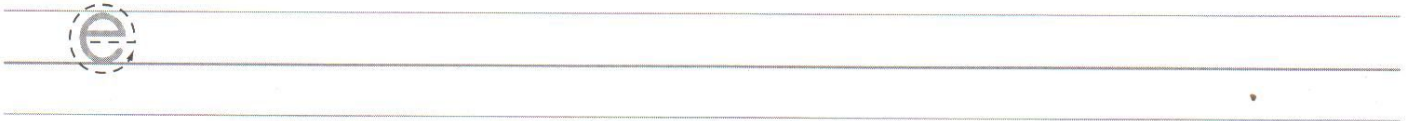
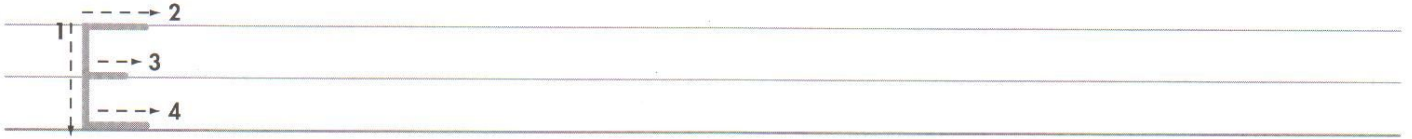

Connect. Trace. Color.

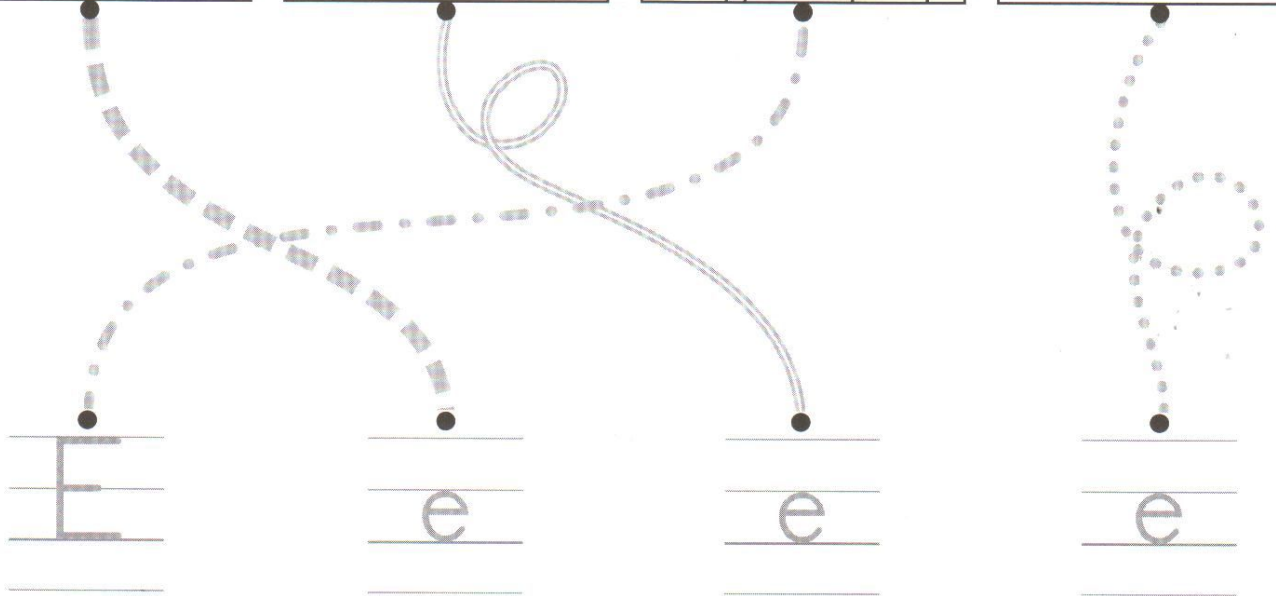
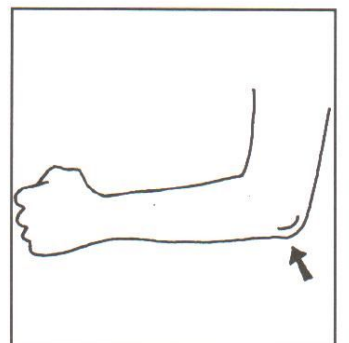
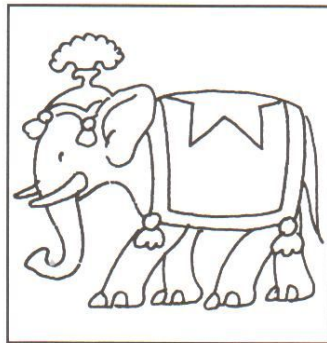
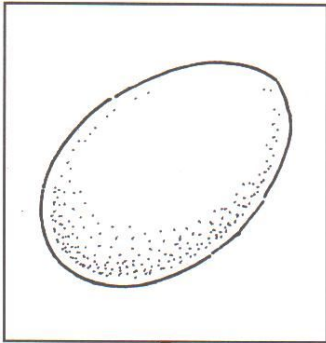

Color.

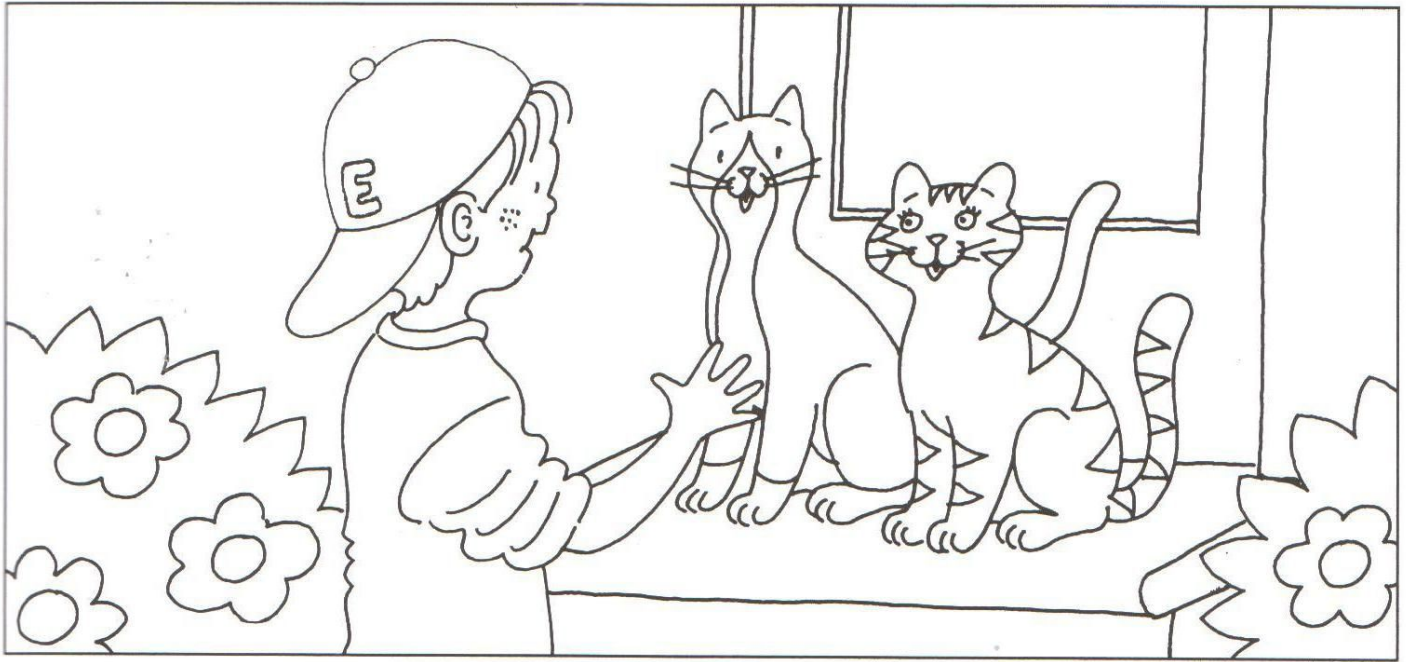

Draw. Color.

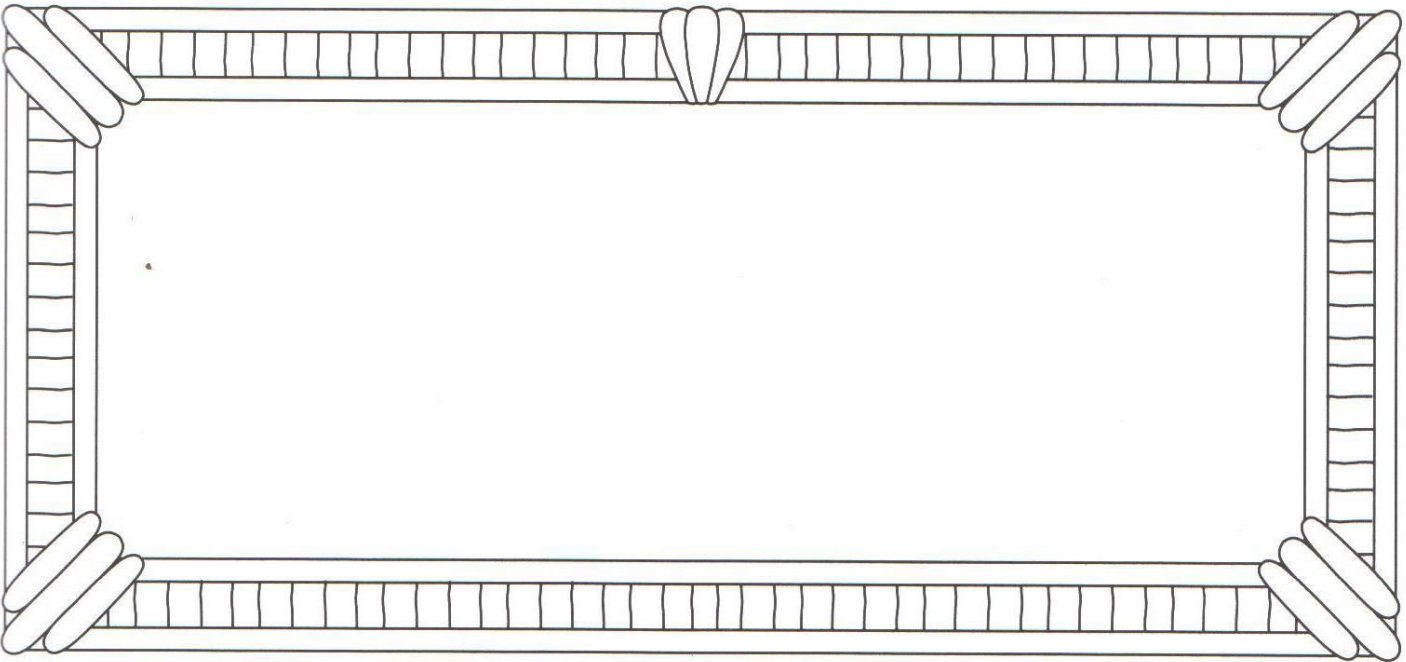

What's your name?



Lesson 3

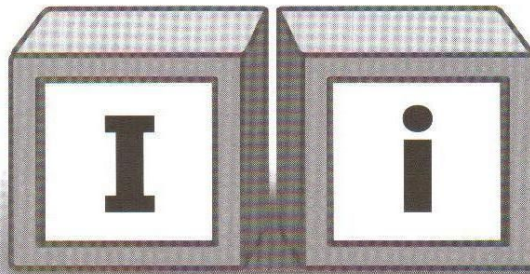

Trace. Write.

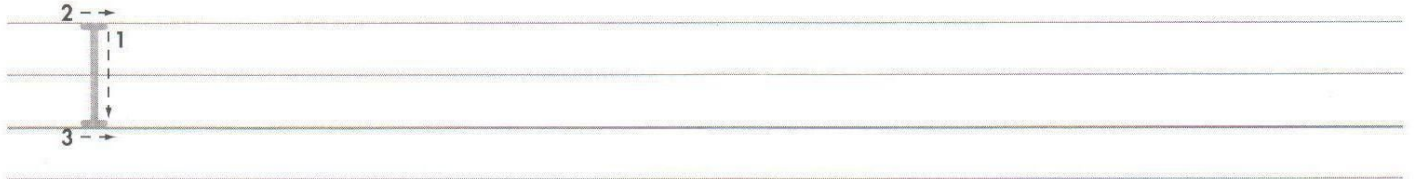

Match. Color.

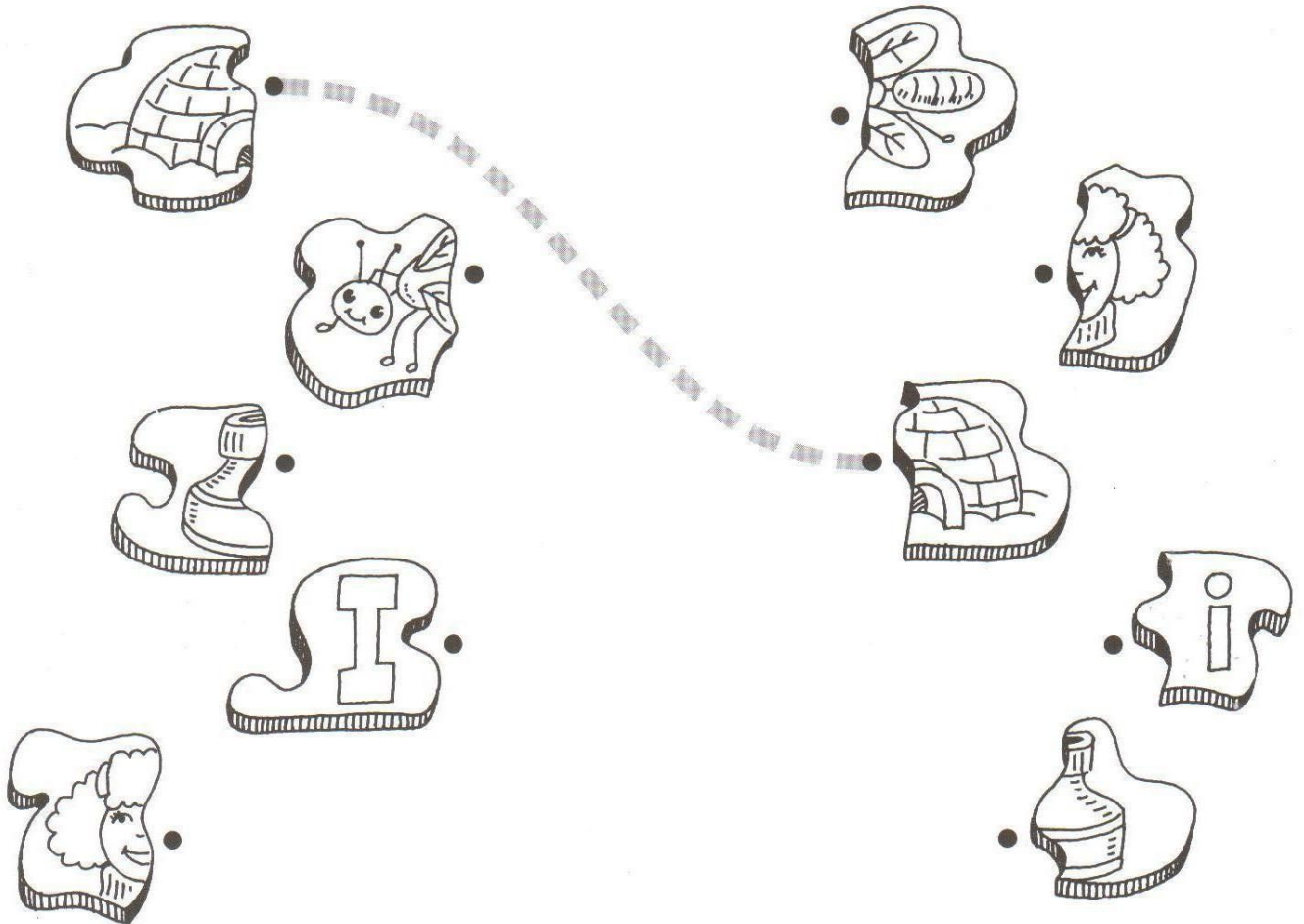

Color.

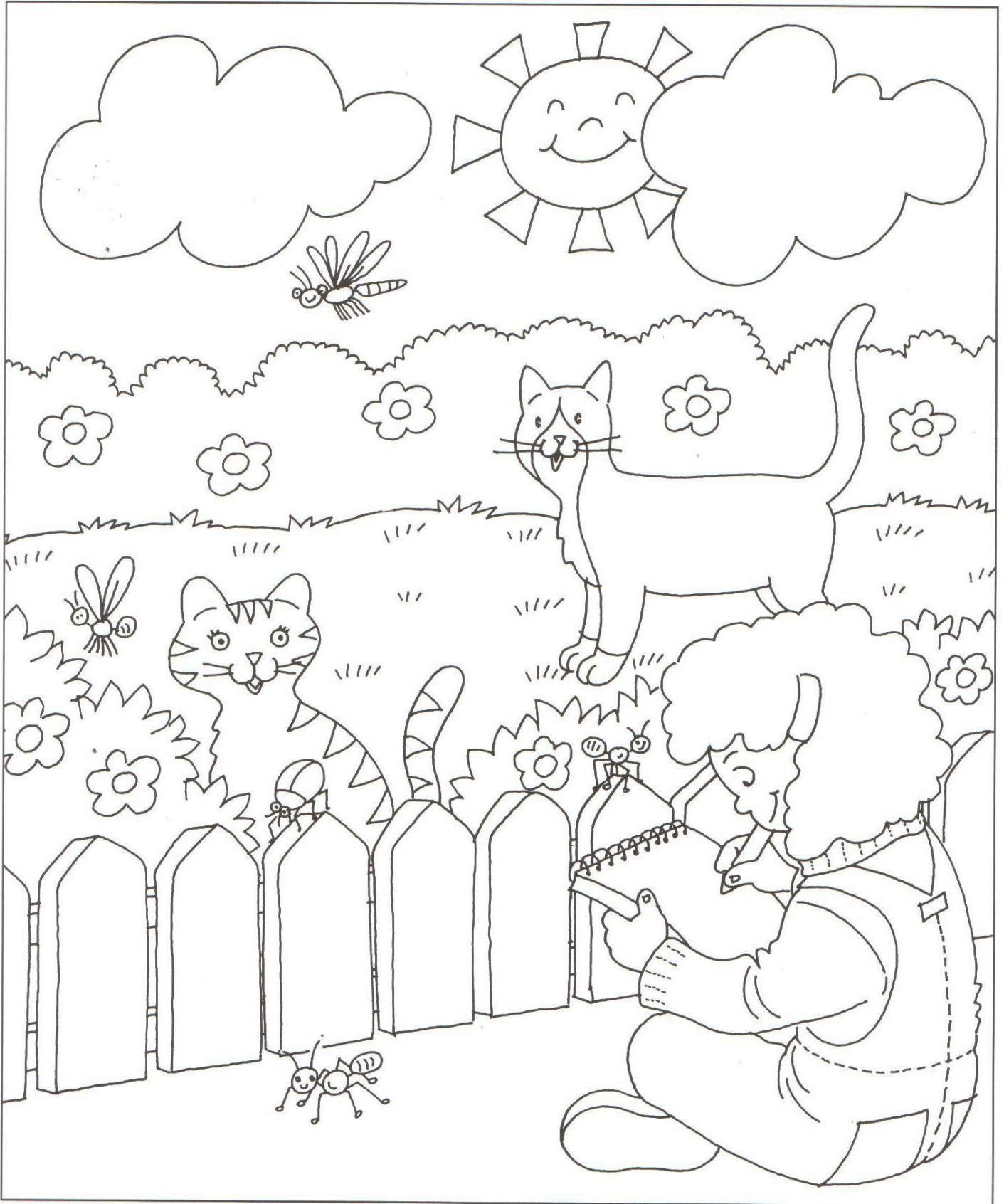



Lesson 4

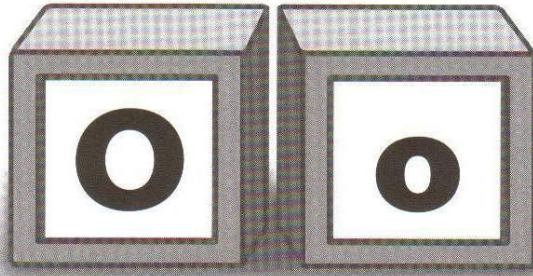

Trace. Write.

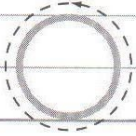

Circle the "o" pictures. Color.

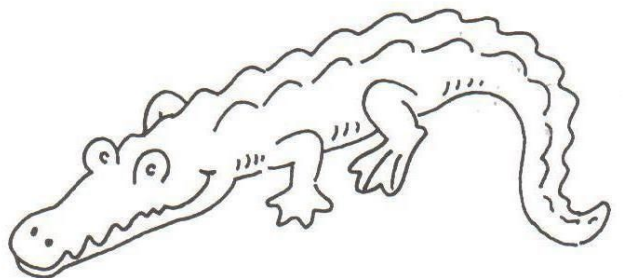
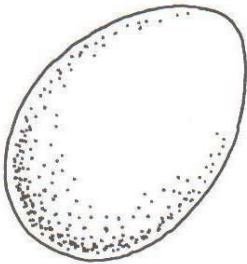
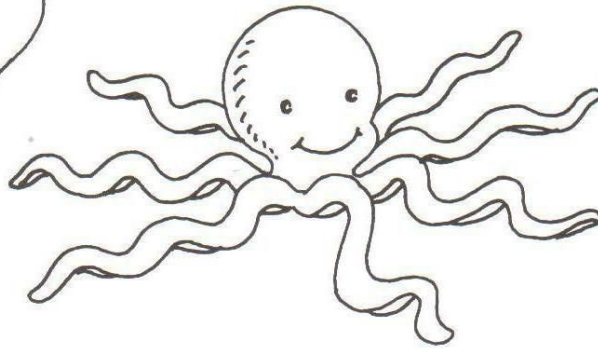
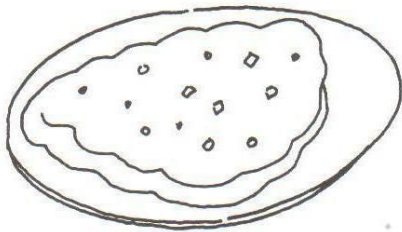

Match. Color.

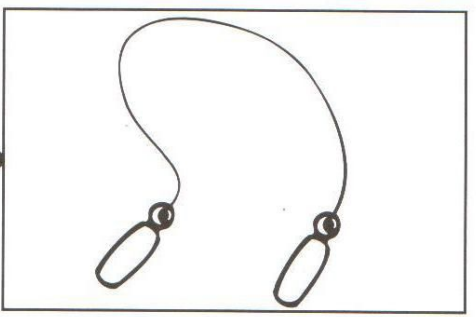
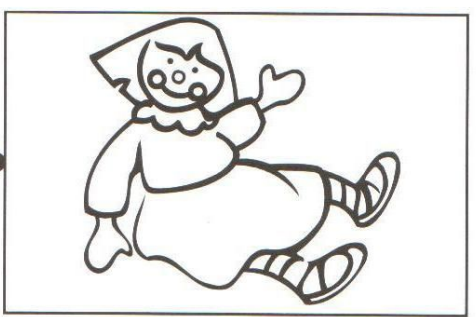
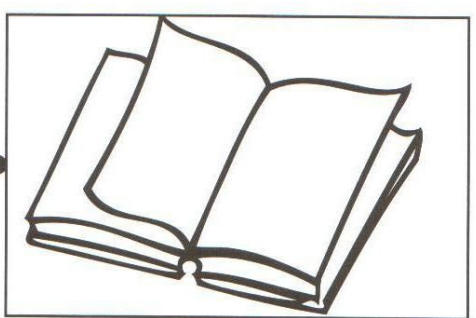
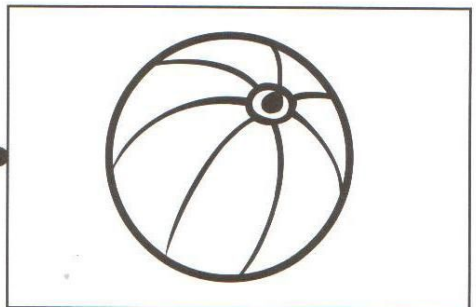
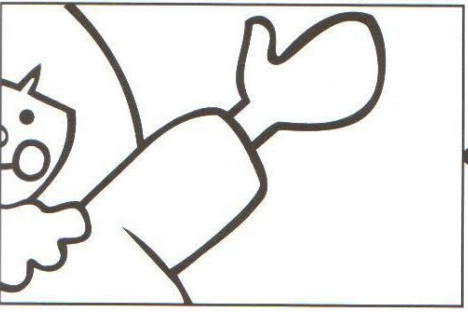
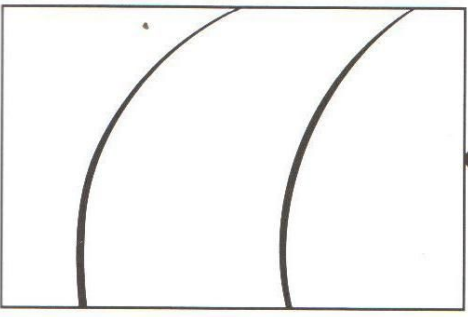
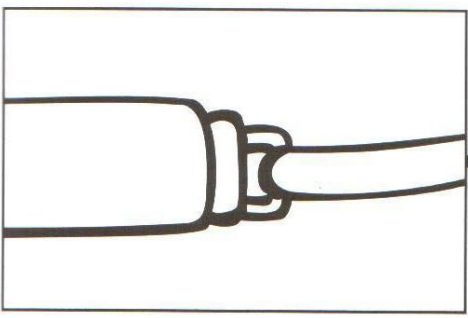
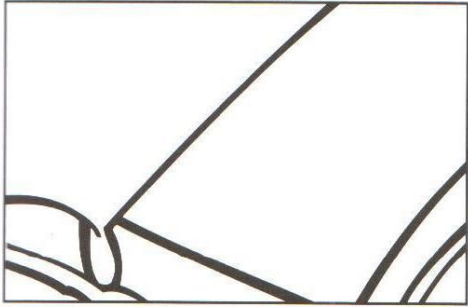
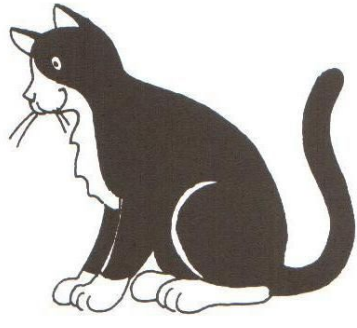
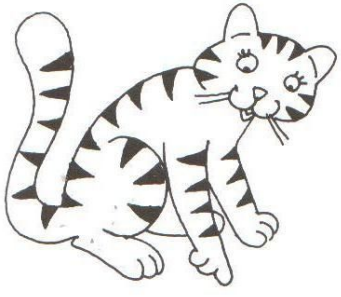



Lesson 5

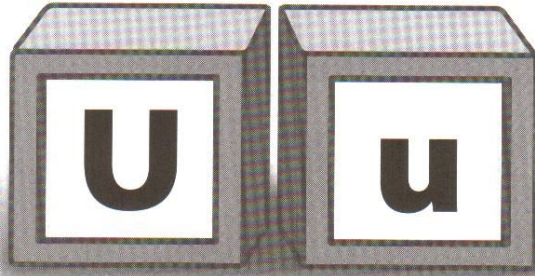

Trace. Write.



Follow. Trace. Color.

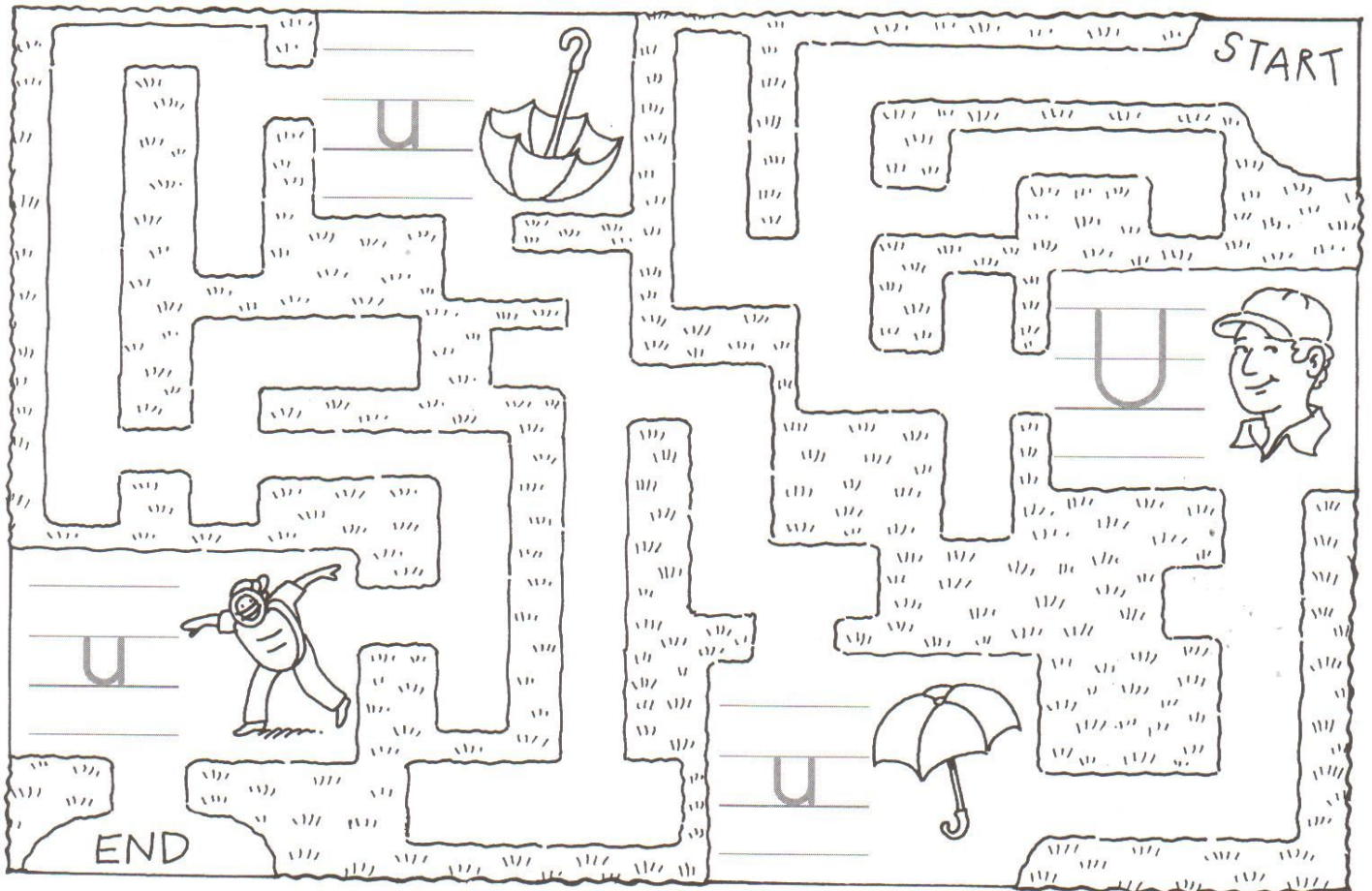

Match. Color.

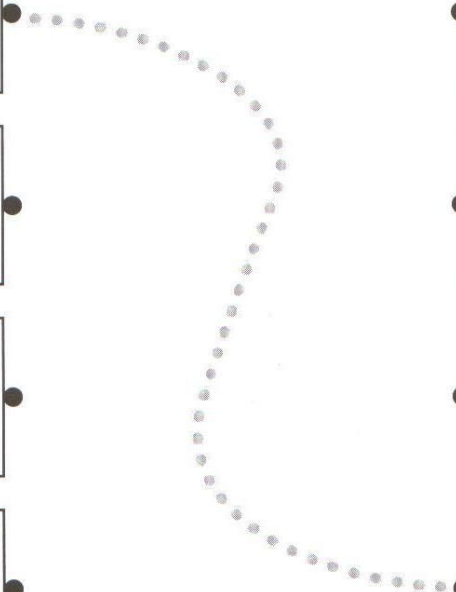
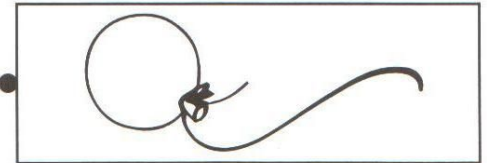
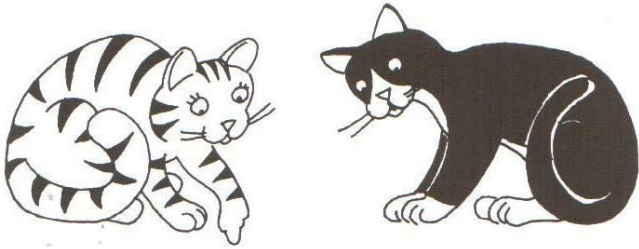

Match. Color.

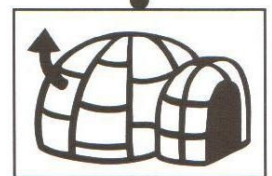
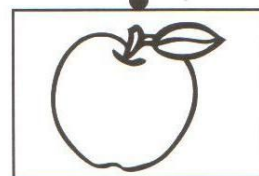
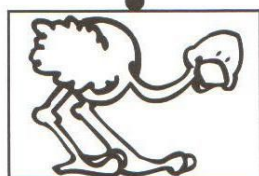
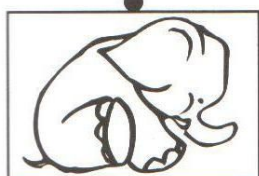
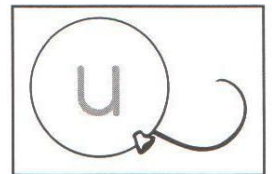
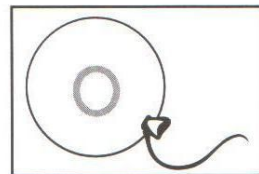
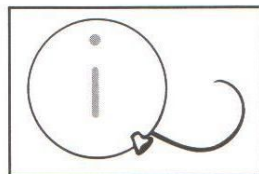
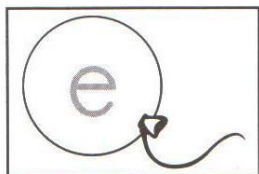
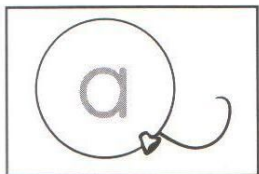



Lesson 6

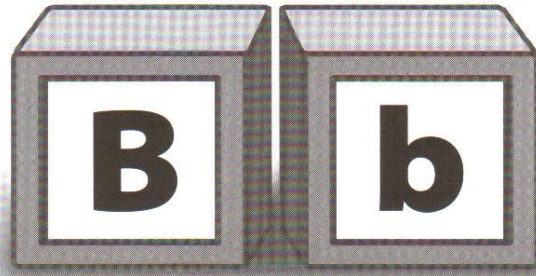

Trace. Write.

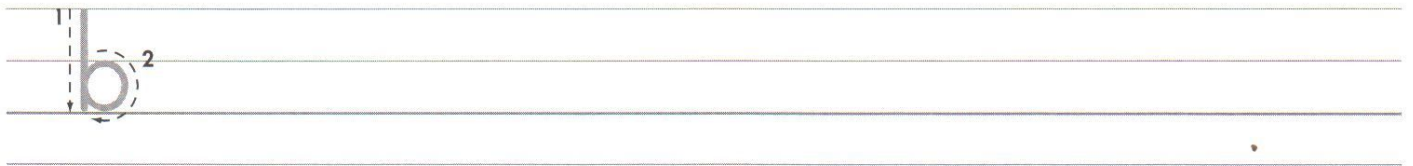
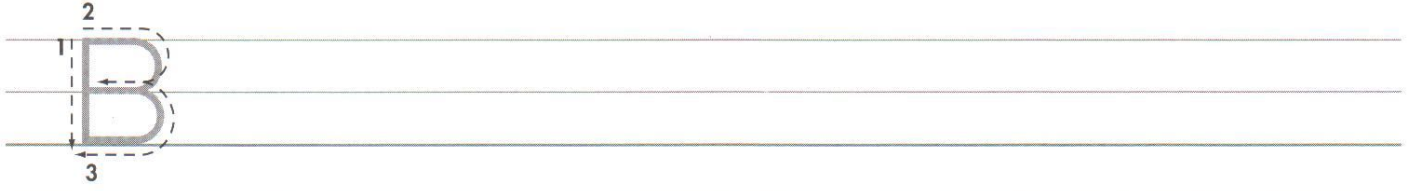

Match. Color.

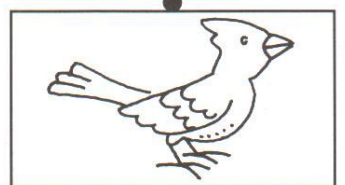
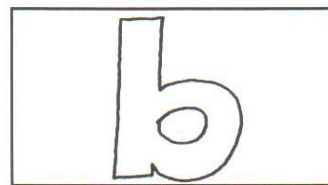
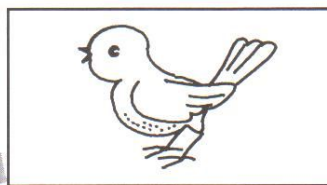
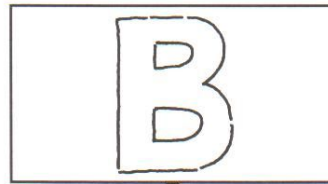
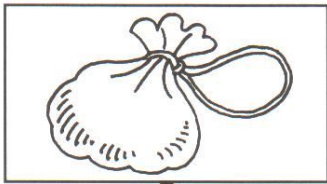

Count. Match. Color.

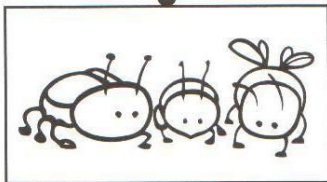
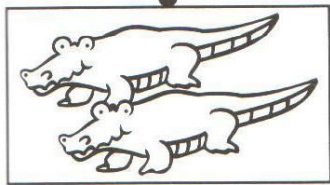
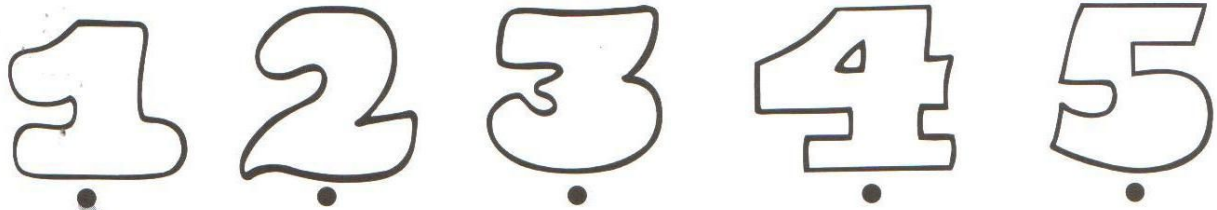

Connect the numbers. Color.

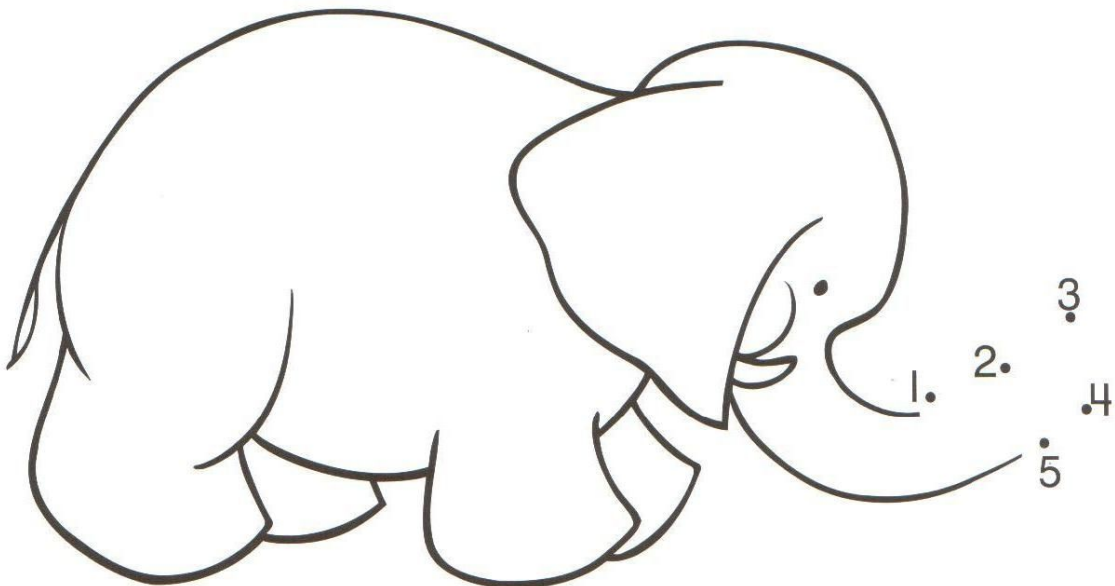



Lesson 7



Trace. Write.



Find. Color.

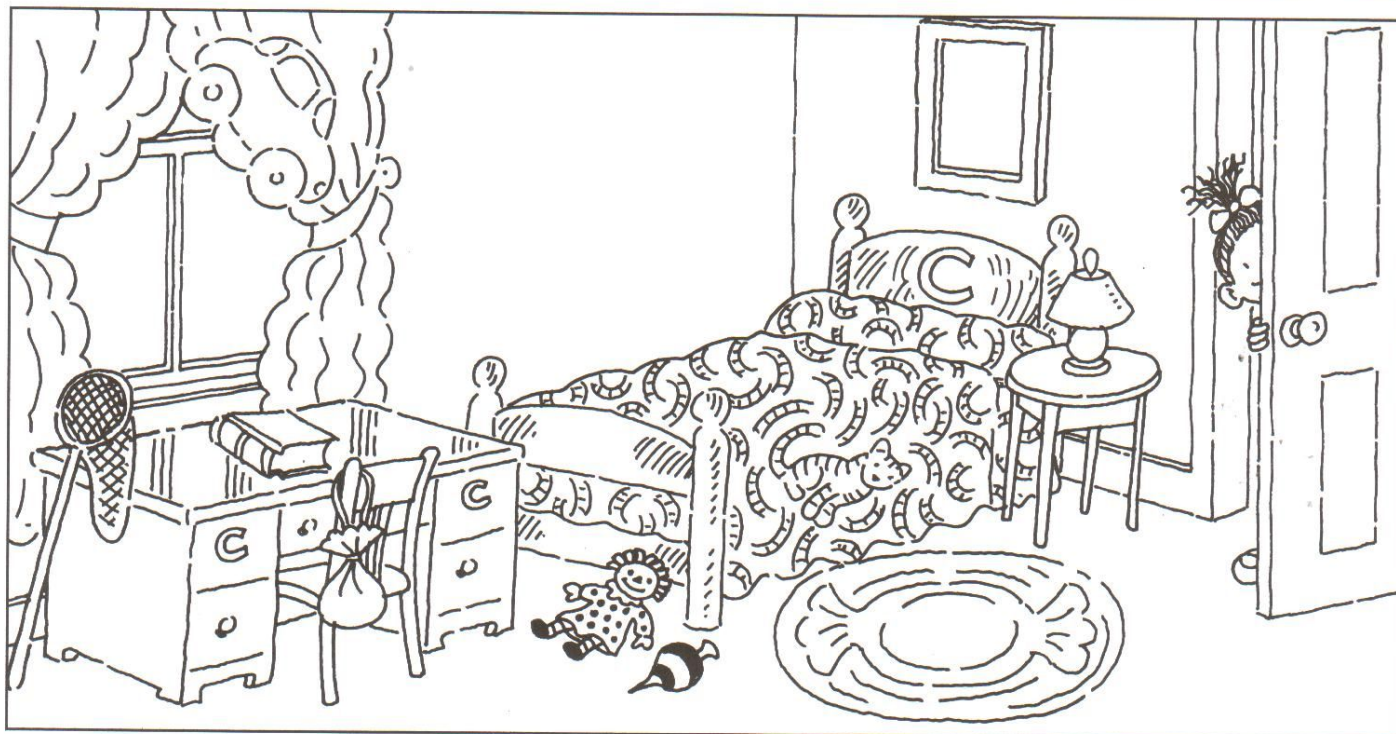
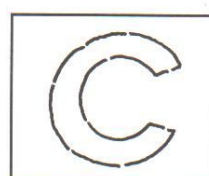
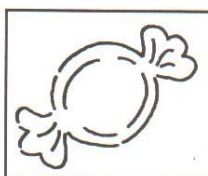

Count. Match. Color.

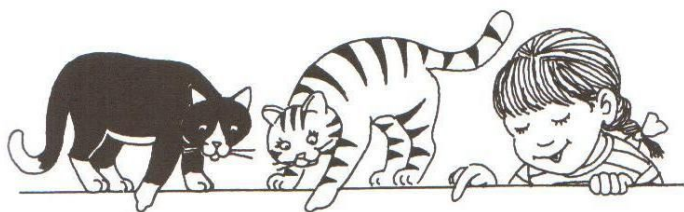

6 7 8 9 10

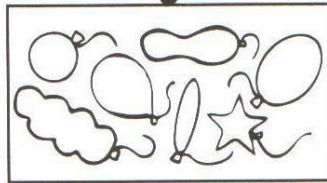
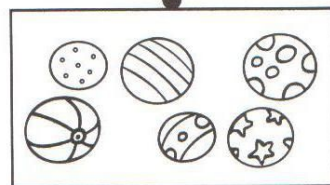
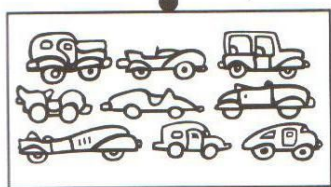

Connect the numbers. Color.

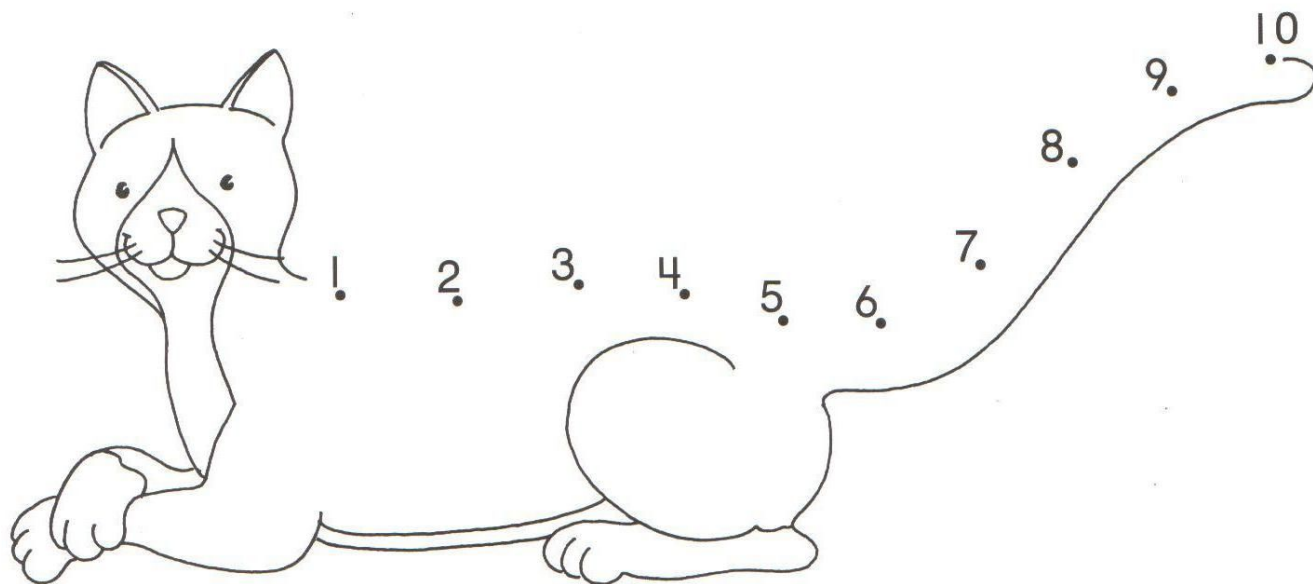



Lesson 8

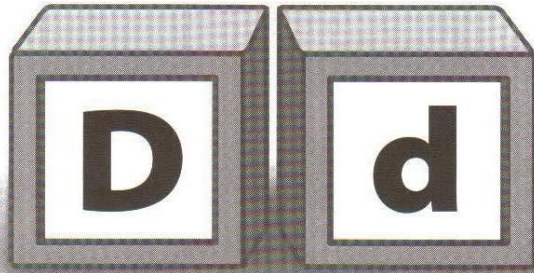

Trace. Write.

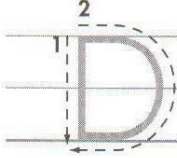

Trace. Color.

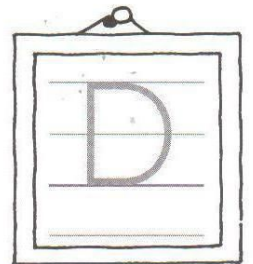
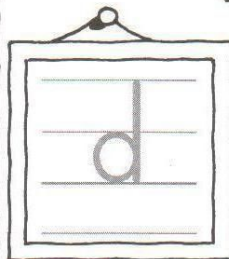
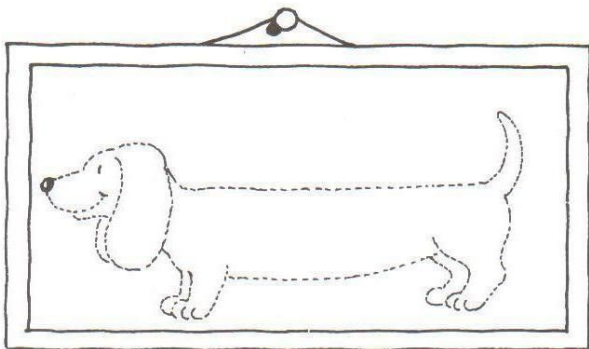
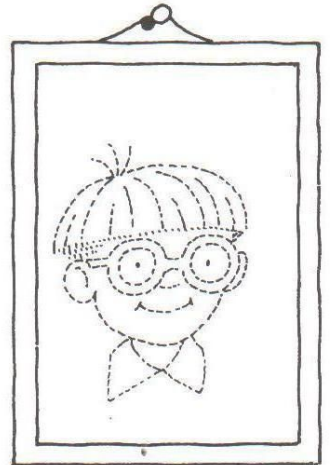
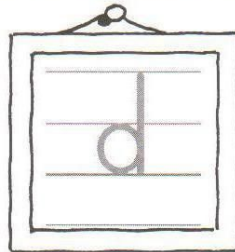
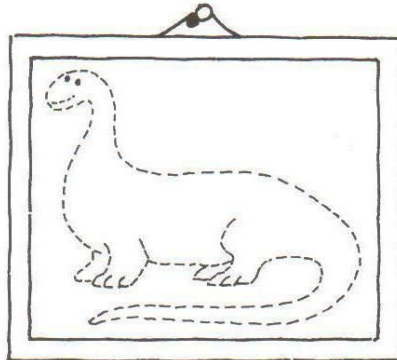
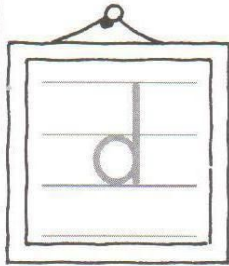
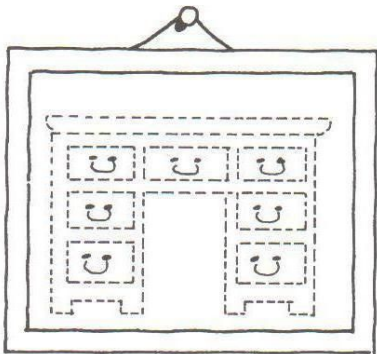

Count. Write. Color.

1 2 3 4 5 6 7 8 9 10

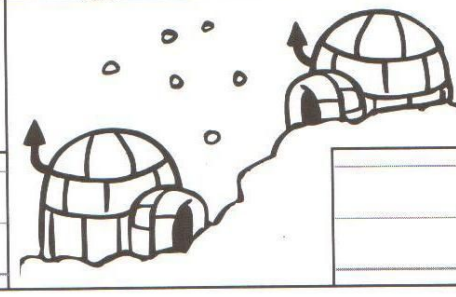
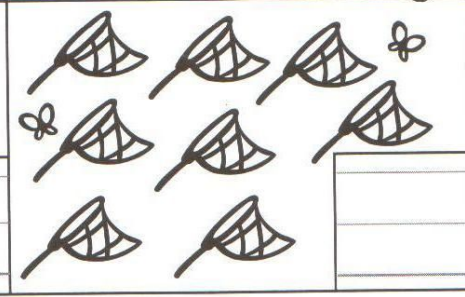
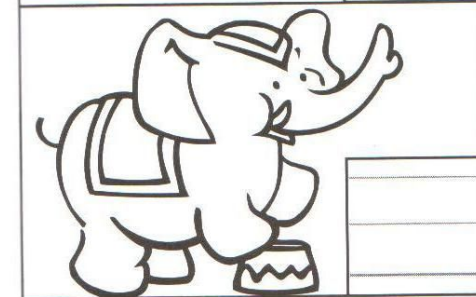
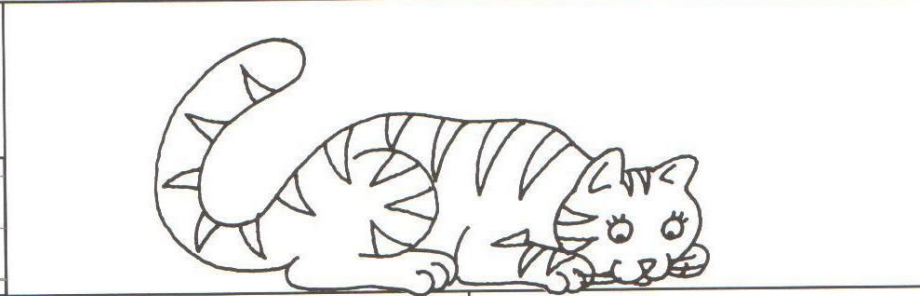
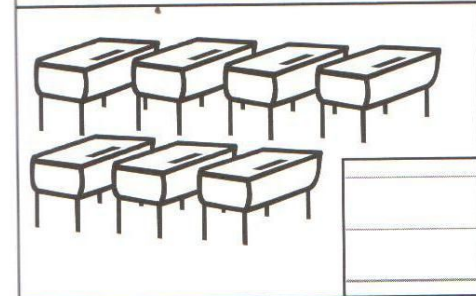
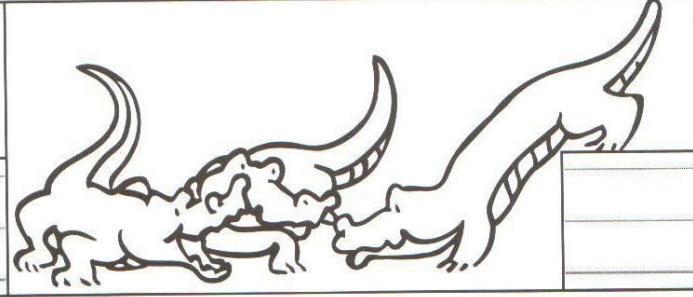
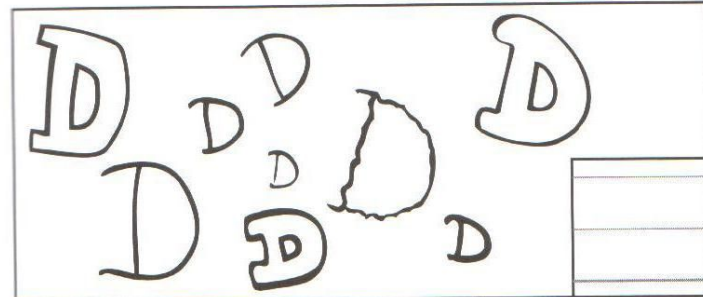
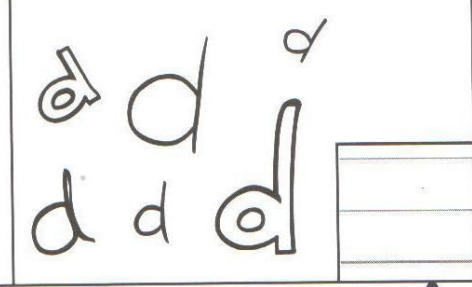
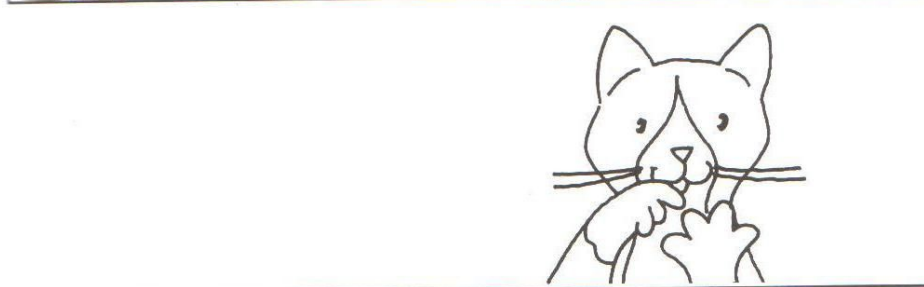
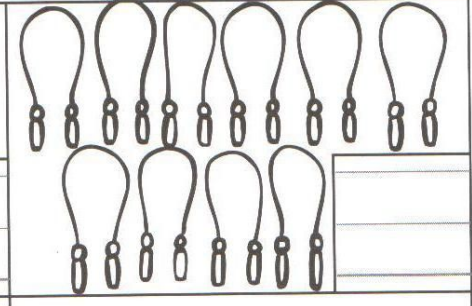
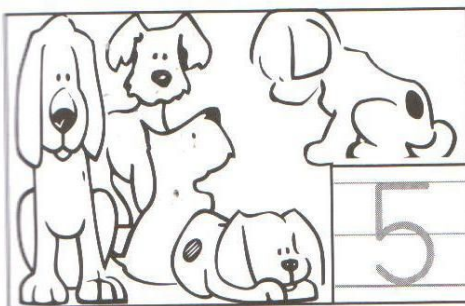



Lesson 9



Trace. Write.

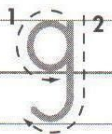
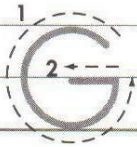

Trace. Color.

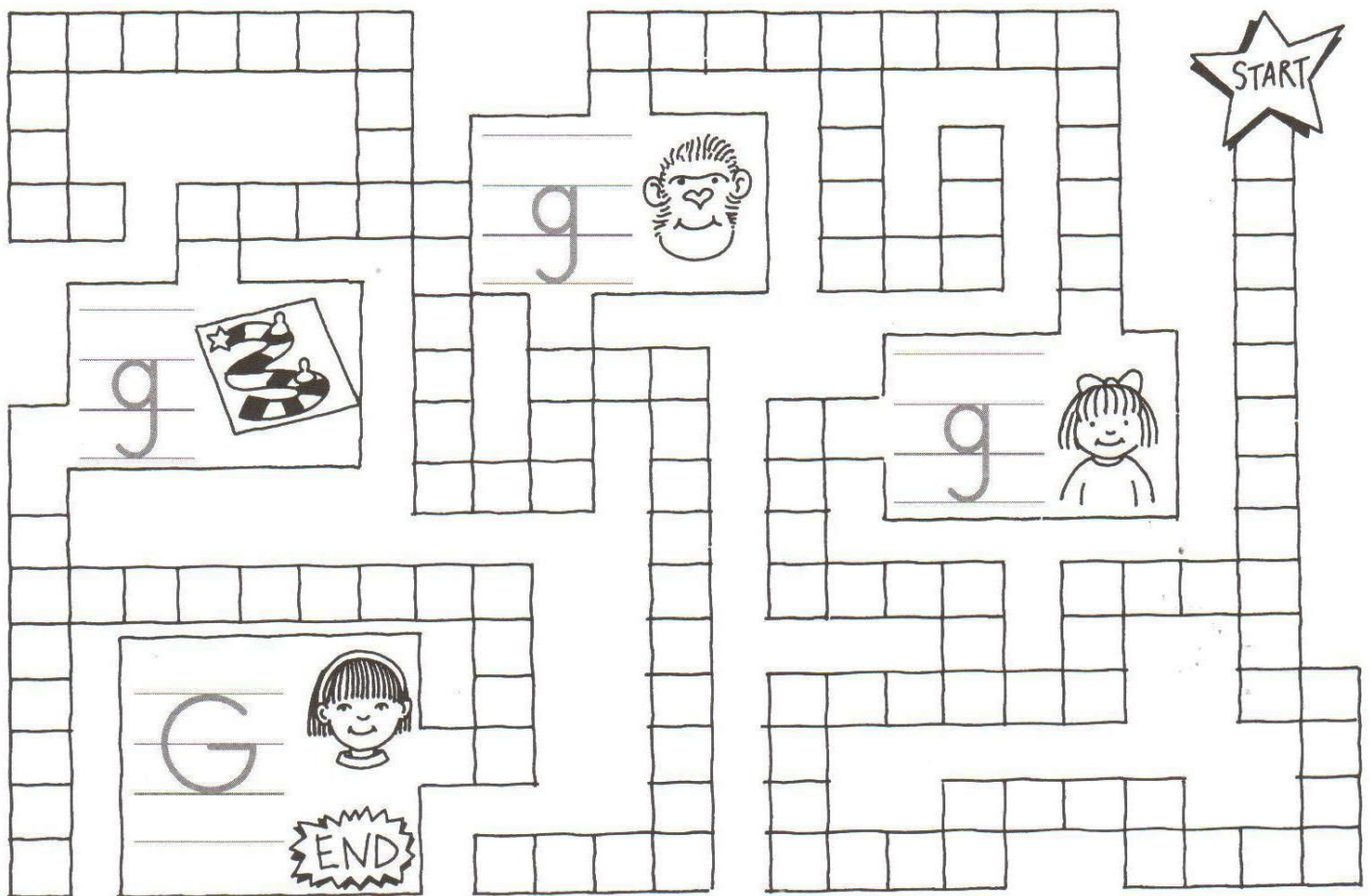

Count. Write. Color.



7



5

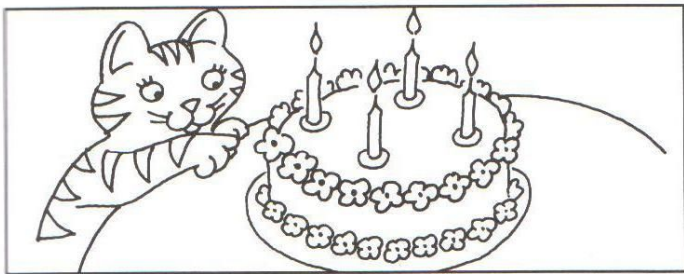

5

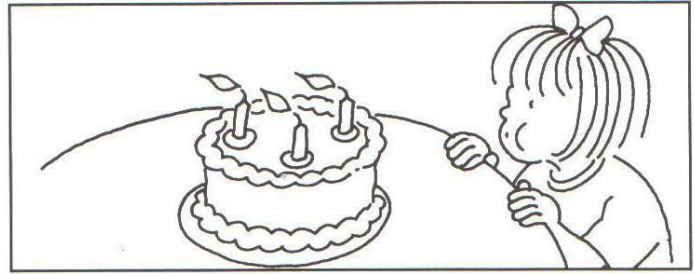

3

Draw. Color.

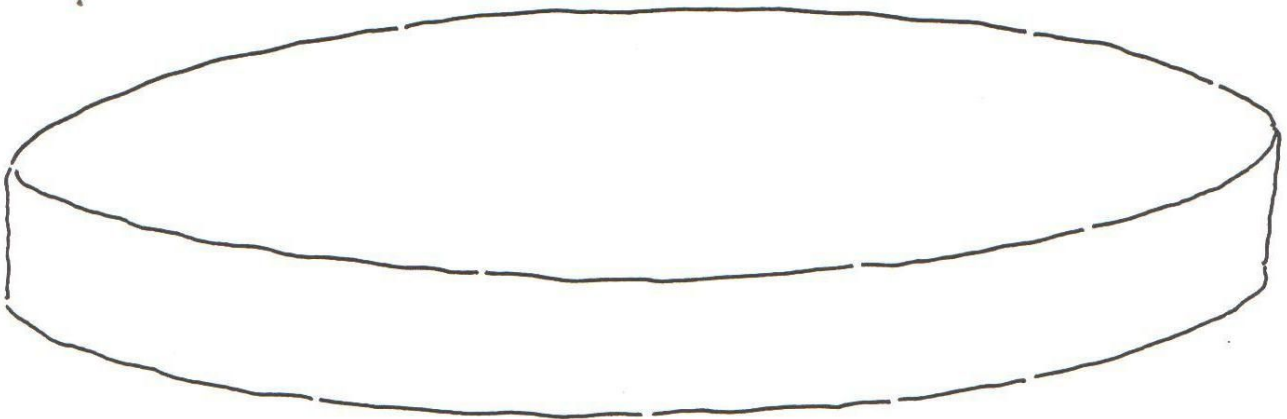

How old are you?



Lesson 10



Trace. Write.

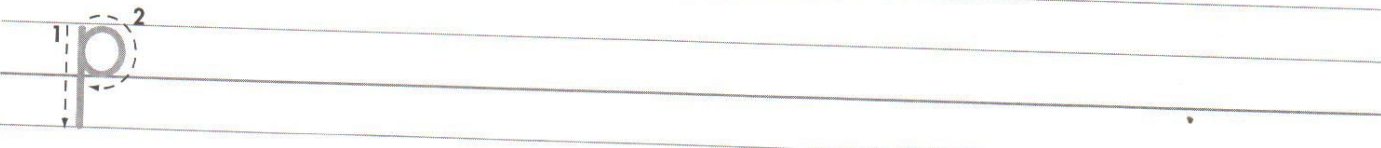
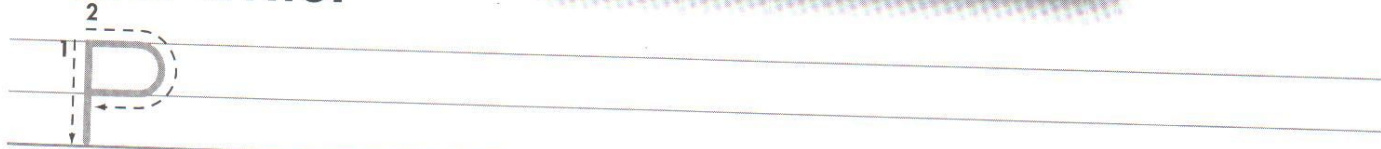

Trace. Color.

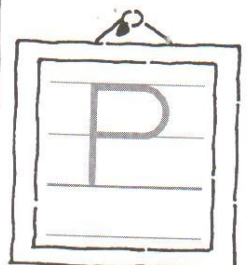
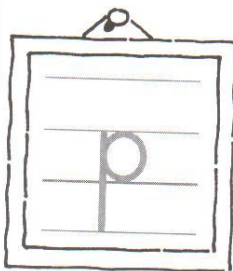
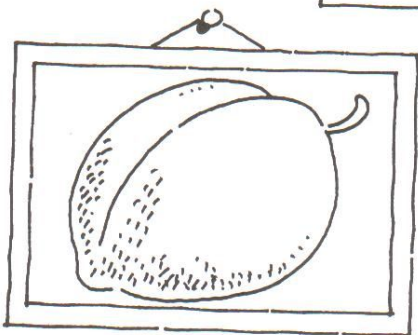
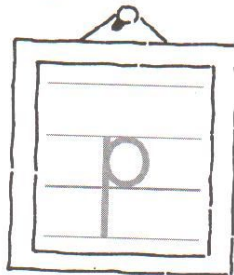
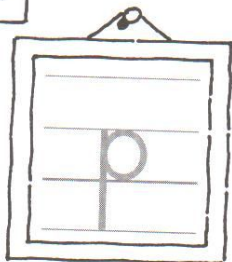
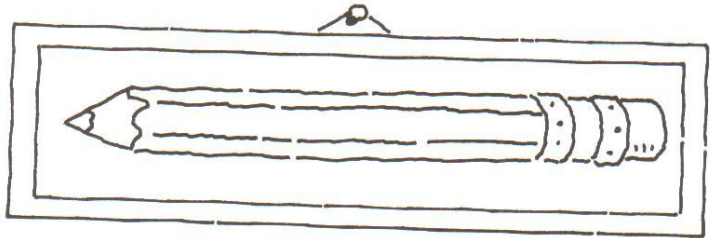

Count. Write. Color.

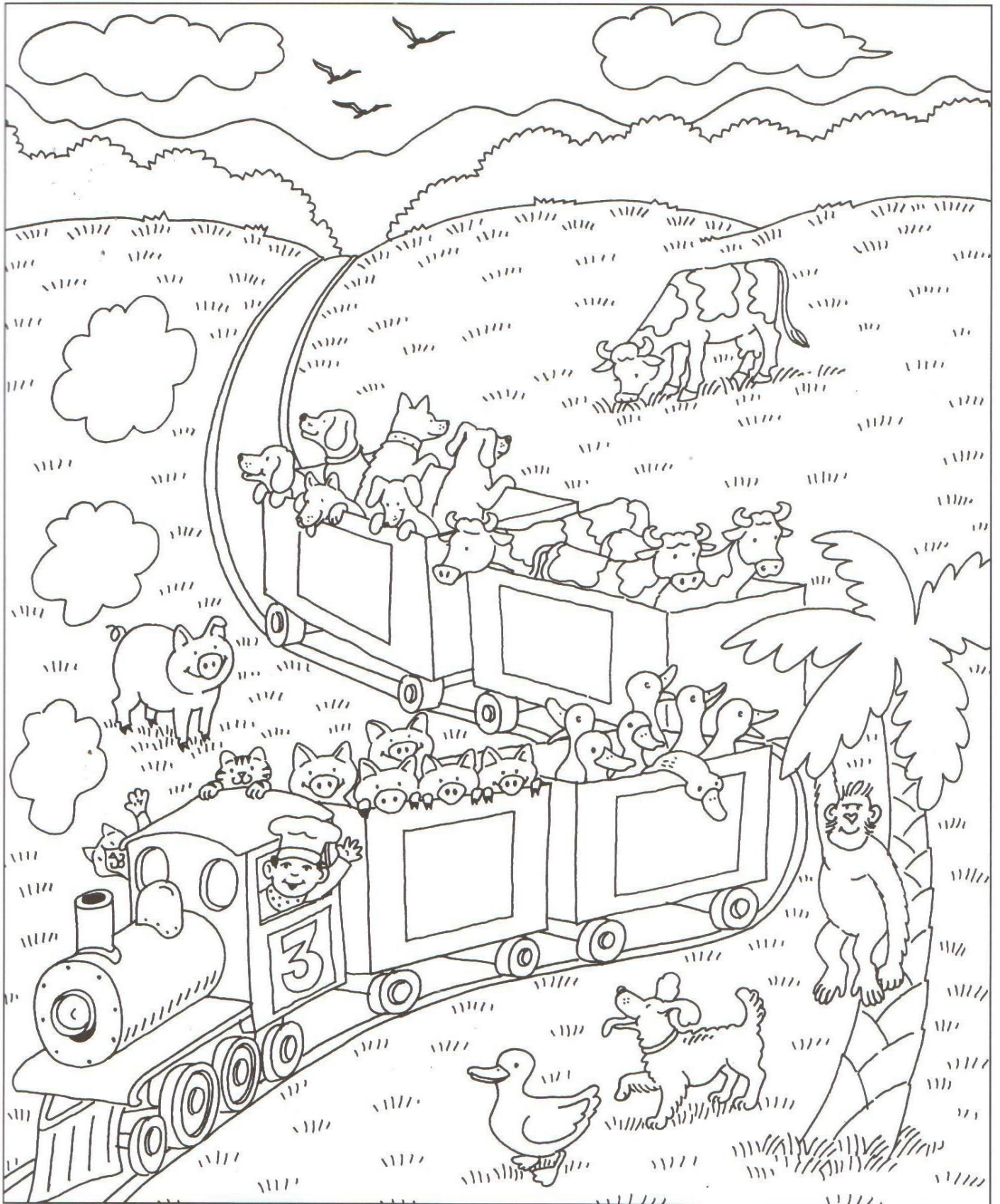



Lesson 11

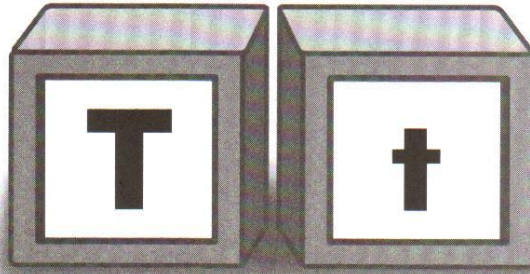

Trace. Write.

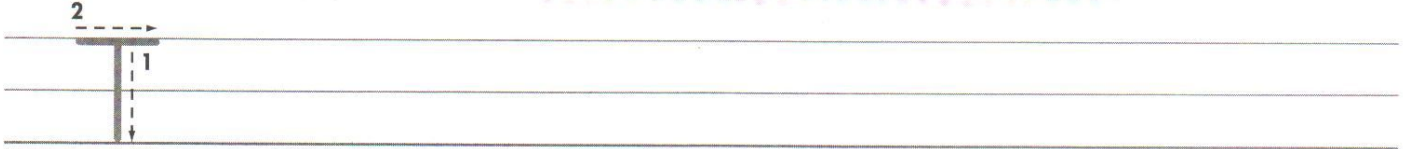

Connect. Trace. Color.

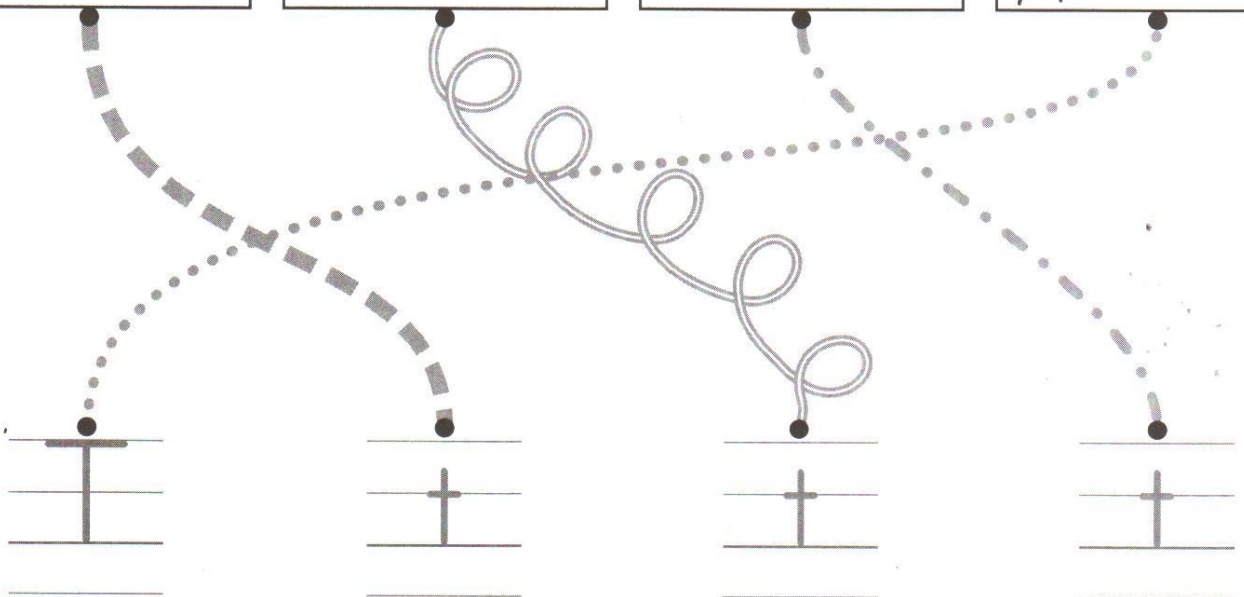
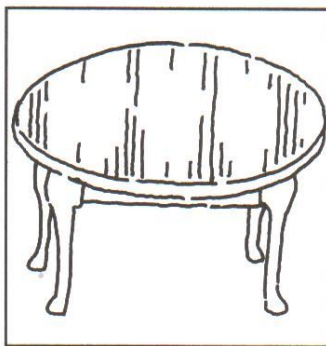
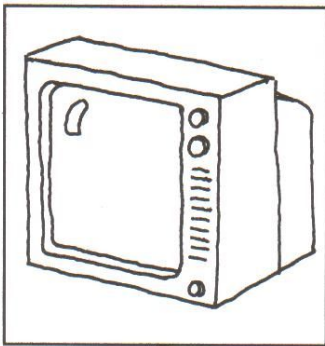

Match. Color.

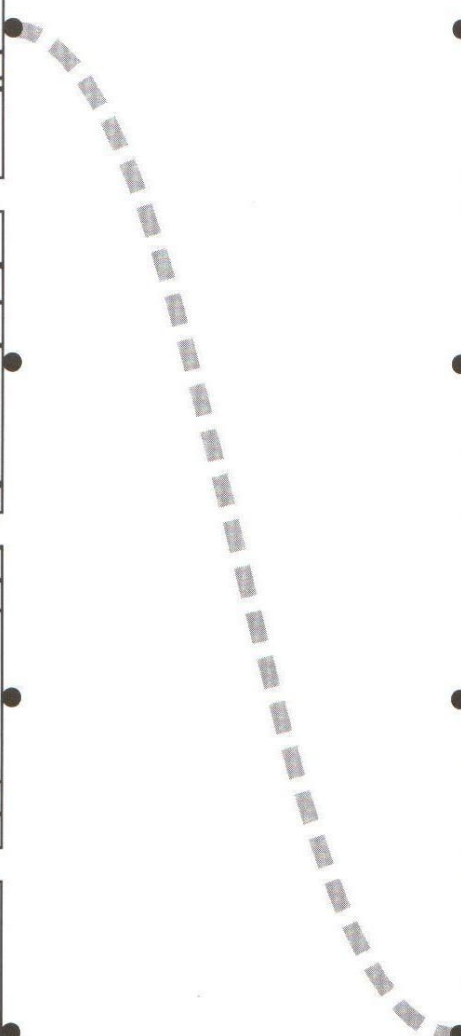
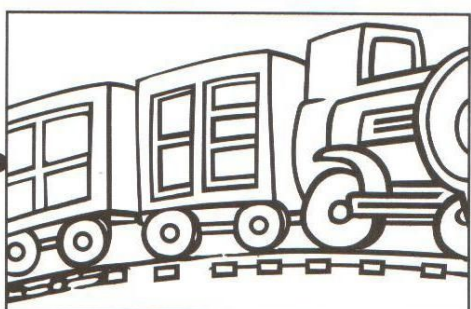
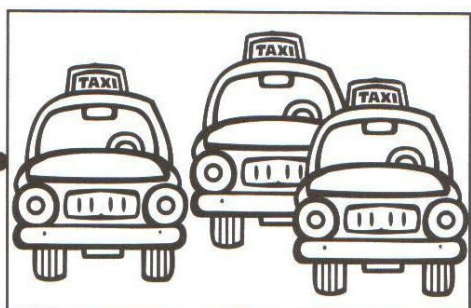
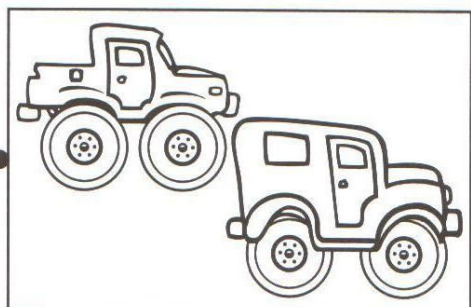
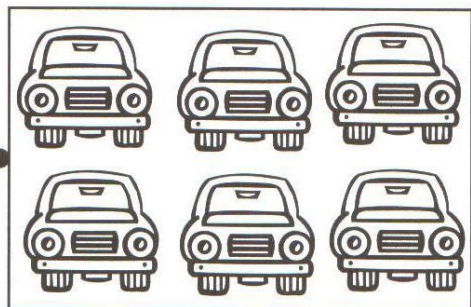
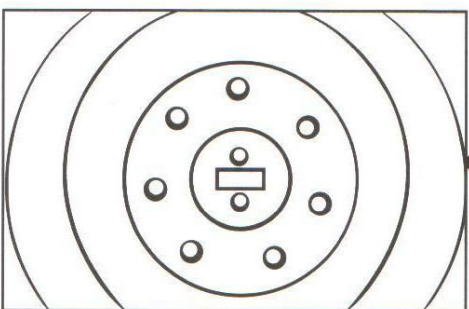
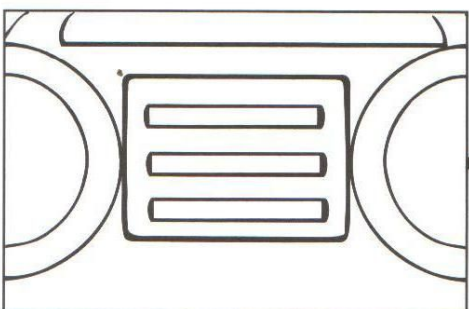
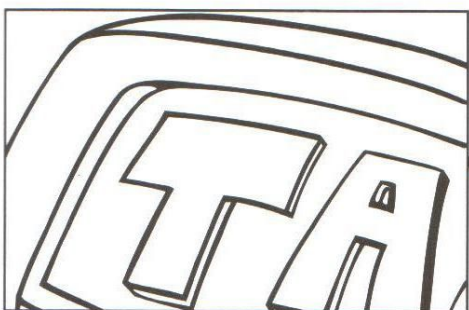
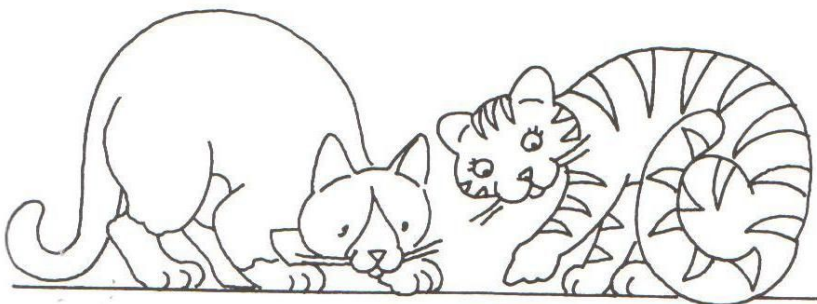



Lesson 12



Trace. Write.

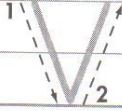

Find. Color.

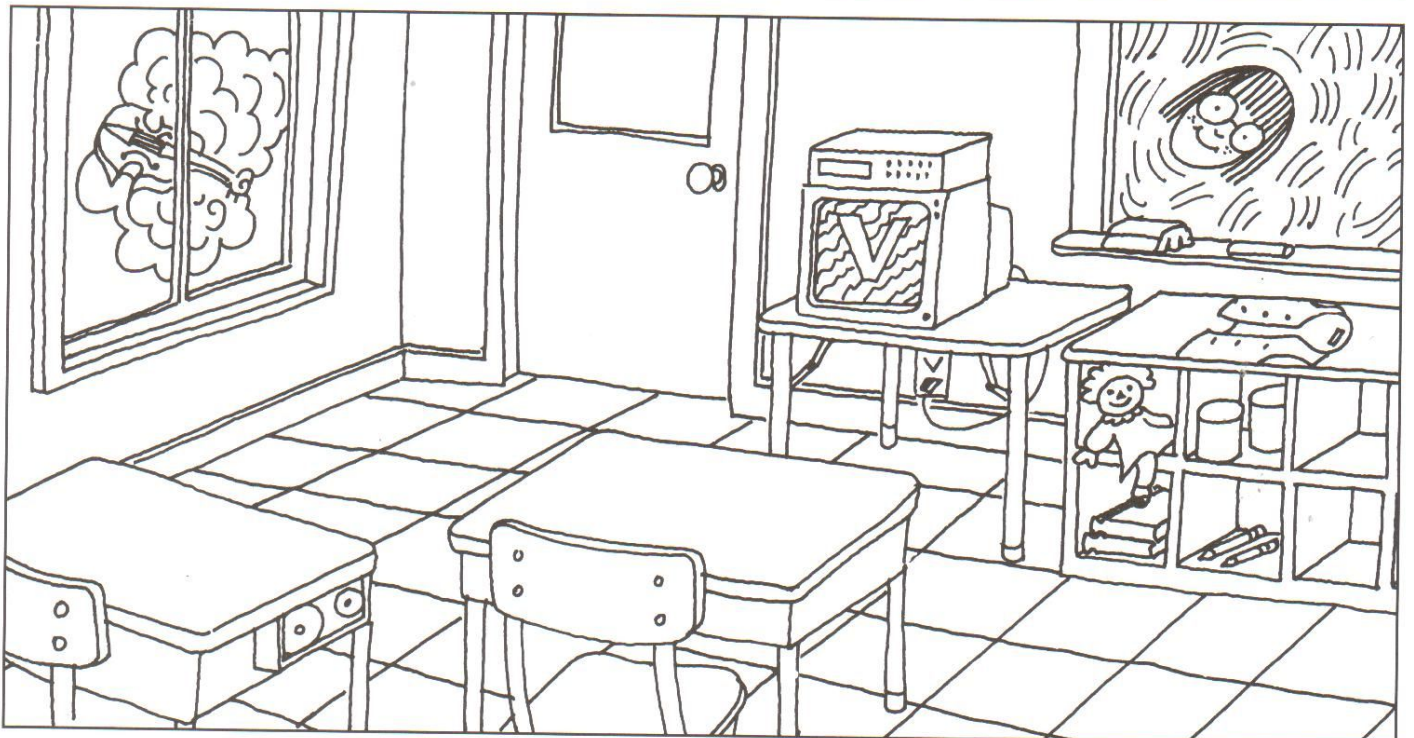
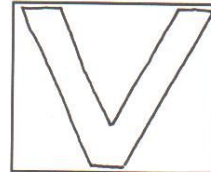
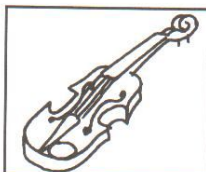
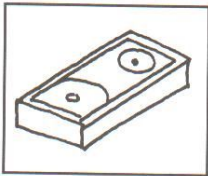

Color.

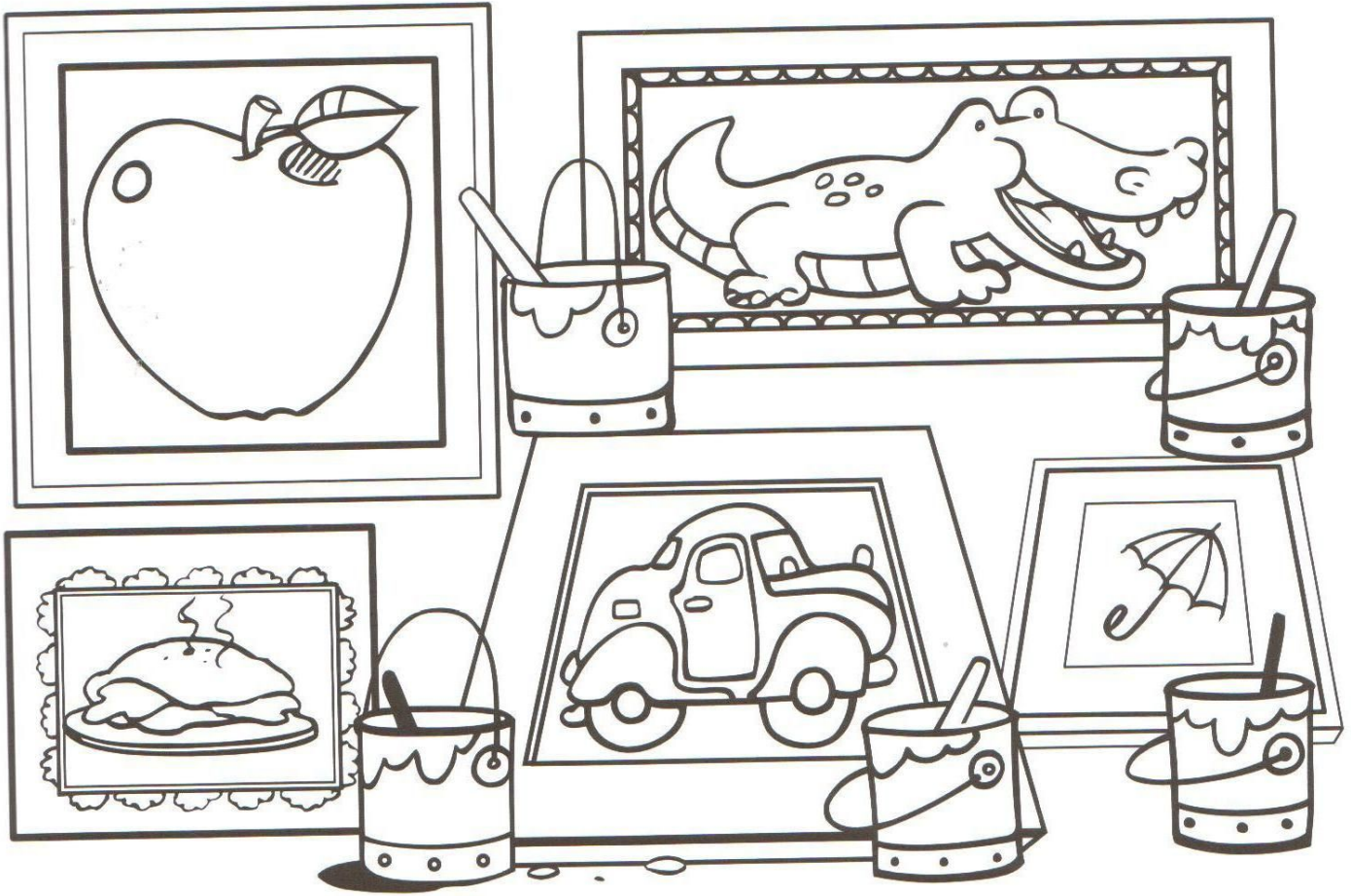

Color.

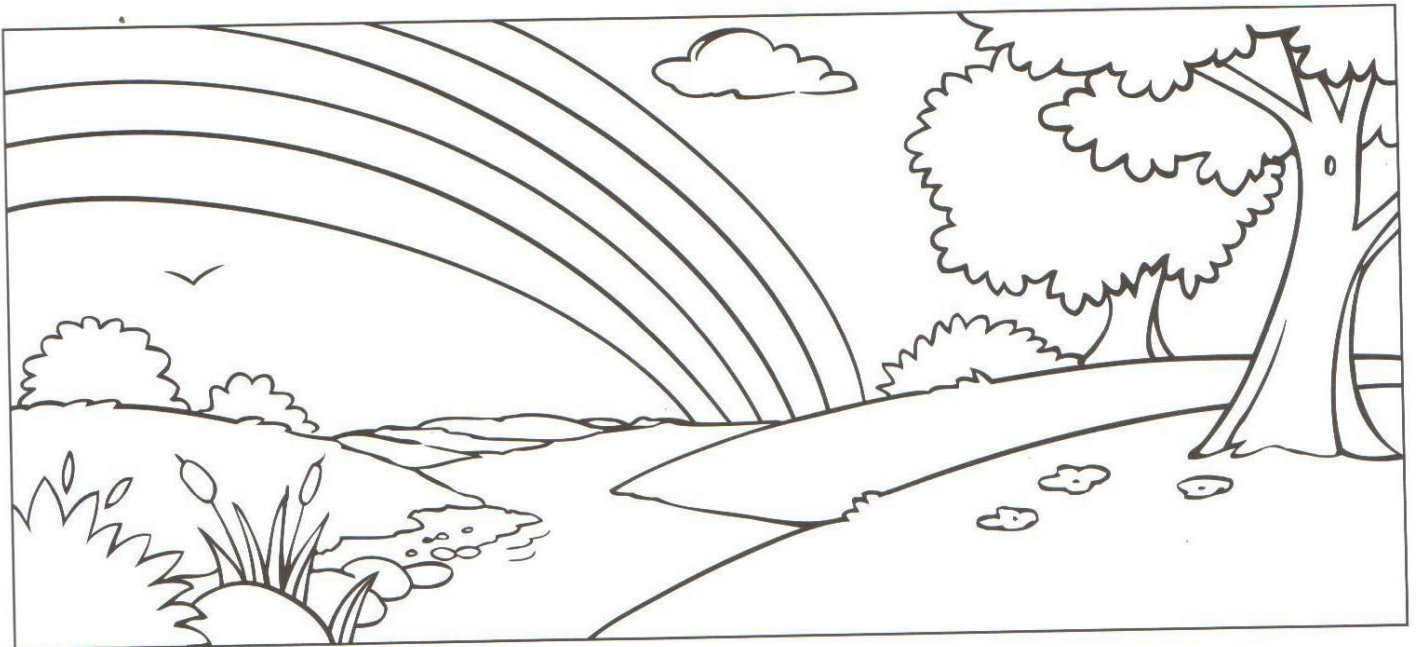



Lesson 13

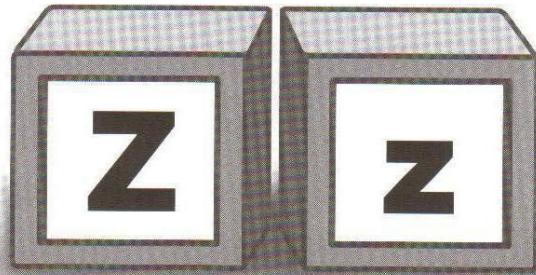

Trace. Write.

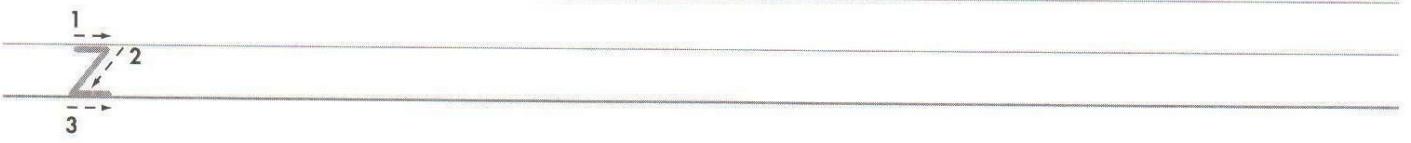

Match. Color.

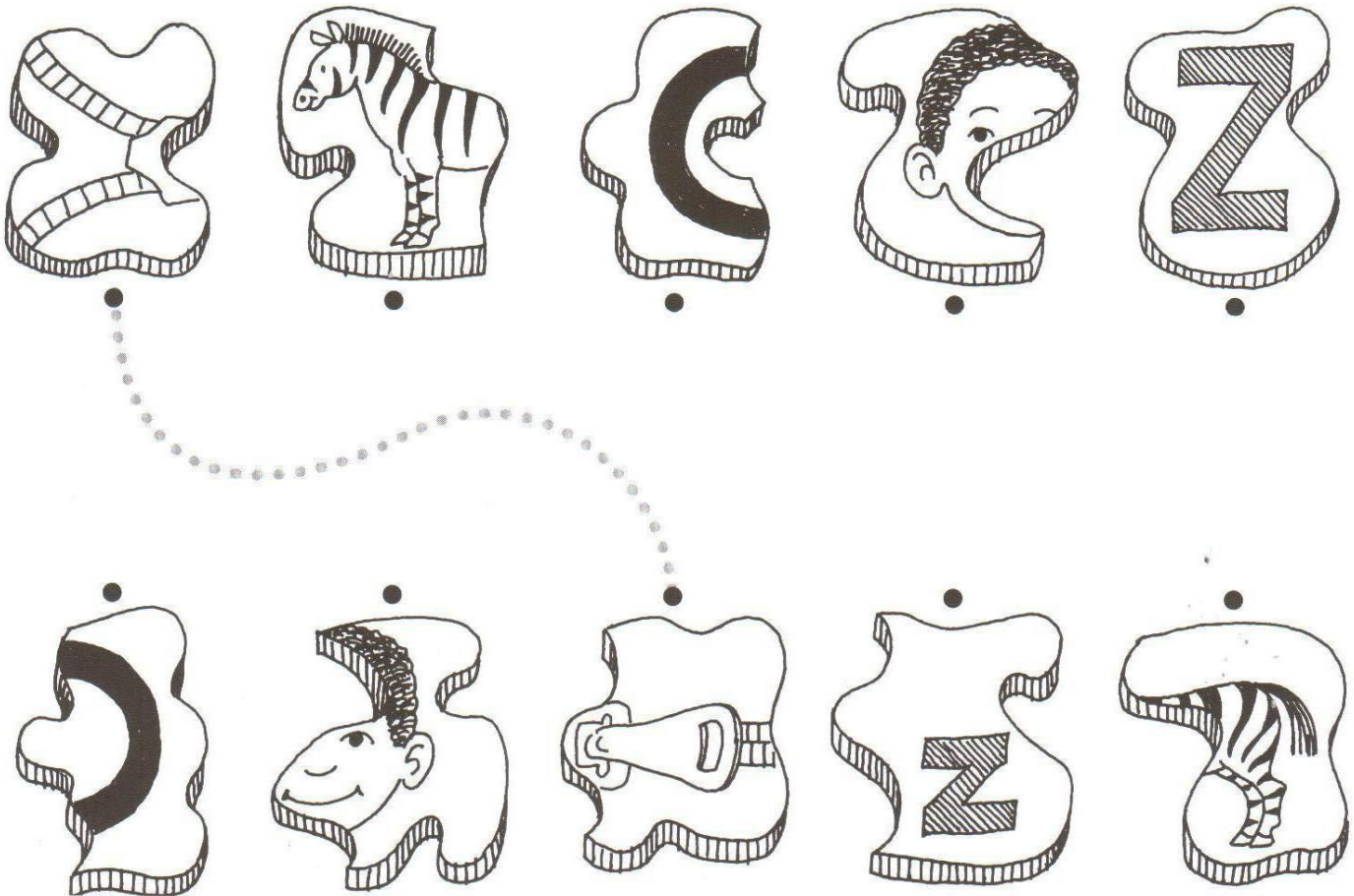

Color.

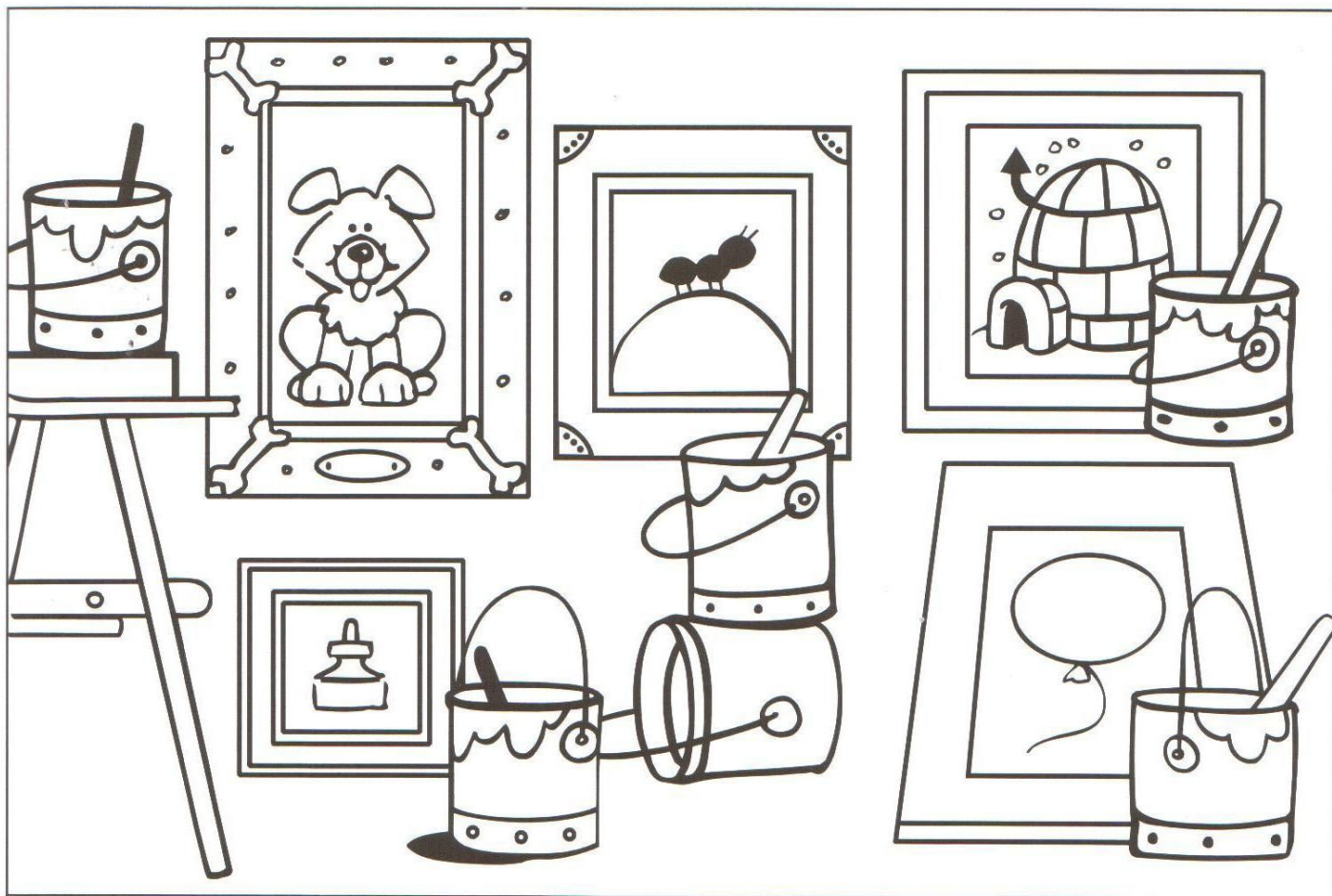

Color.





Lesson 14

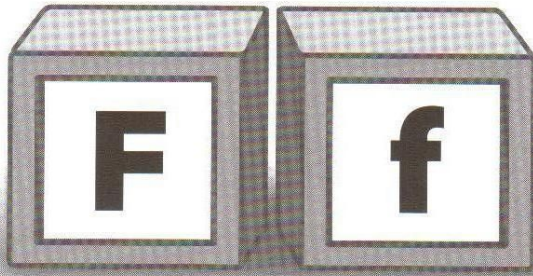

Trace. Write.

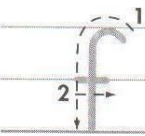
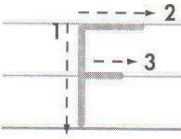

Follow. Trace. Color.

Match. Color.

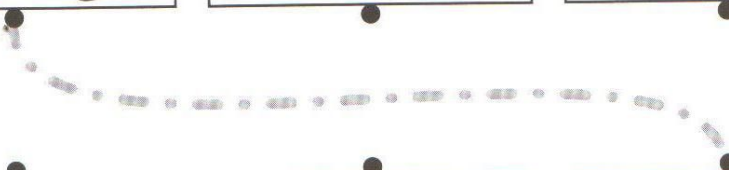
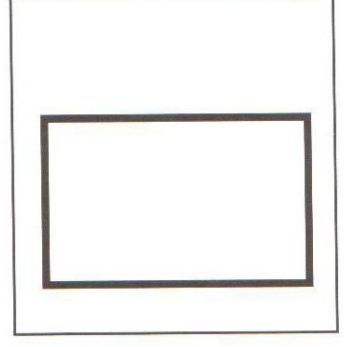
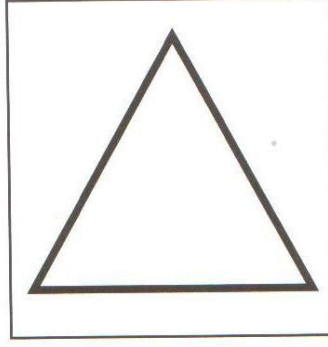
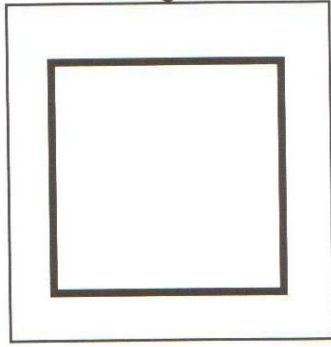
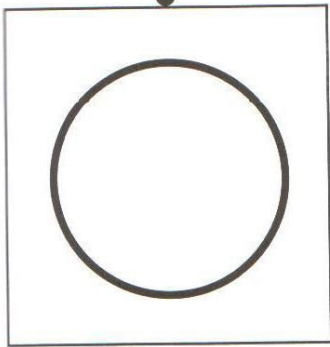
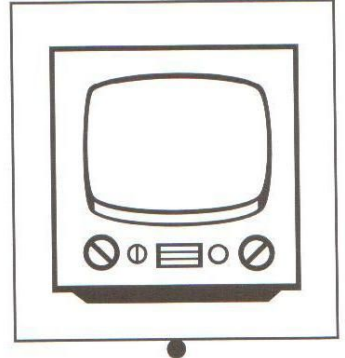
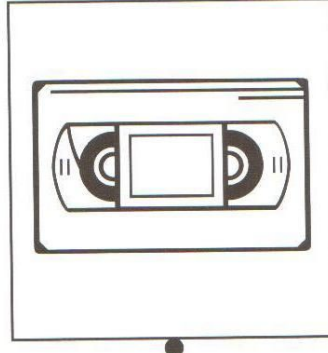
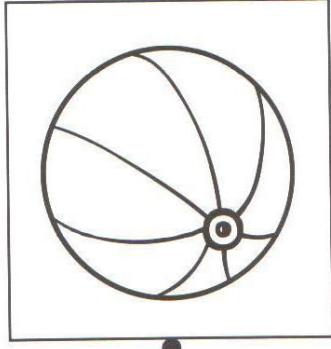

Connect the numbers. Color.

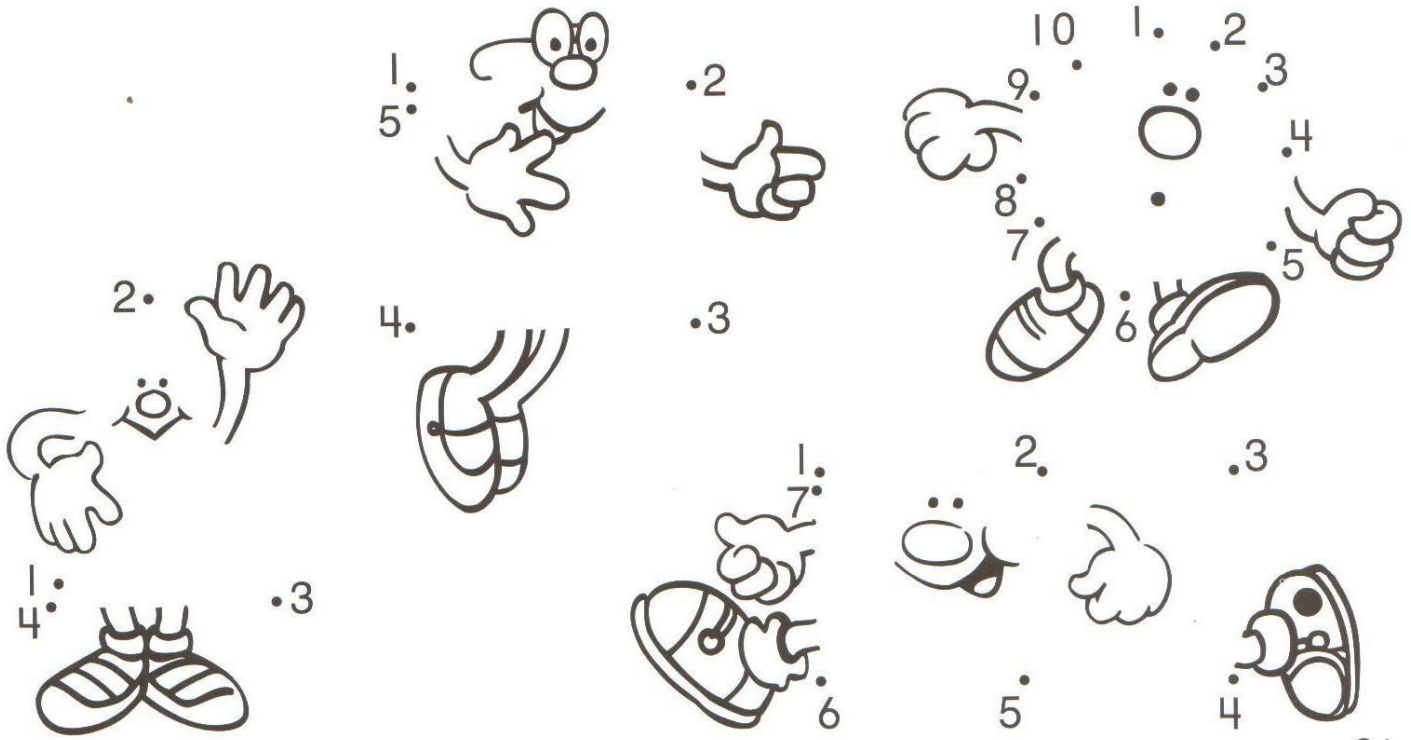



Lesson 15

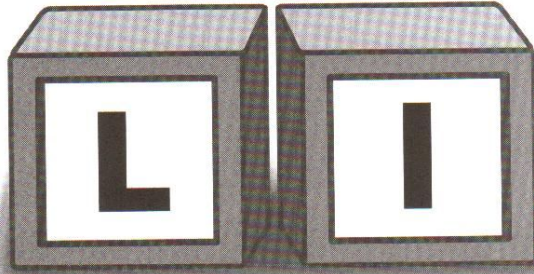

Trace. Write.

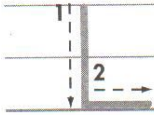

Circle the "l" pictures. Color.

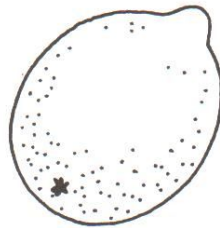
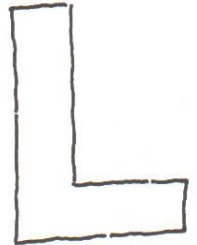
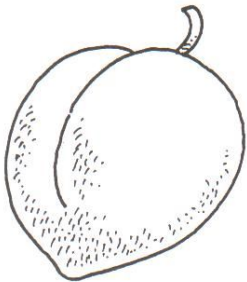

Trace. Color.

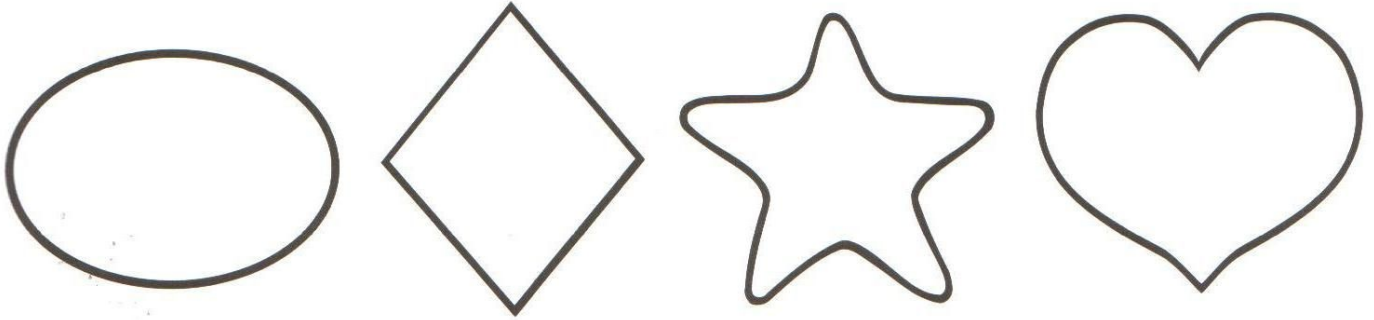

Count. Color.

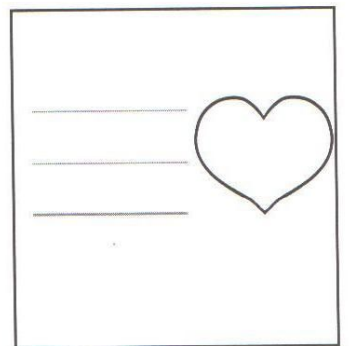
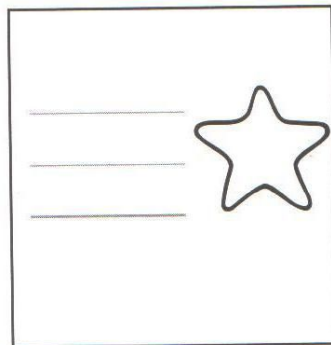
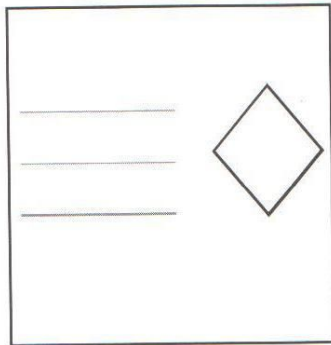
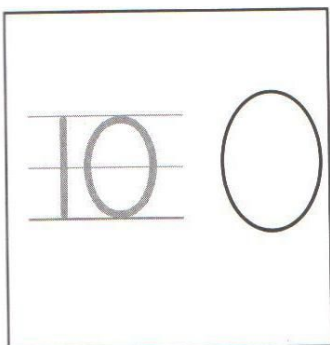
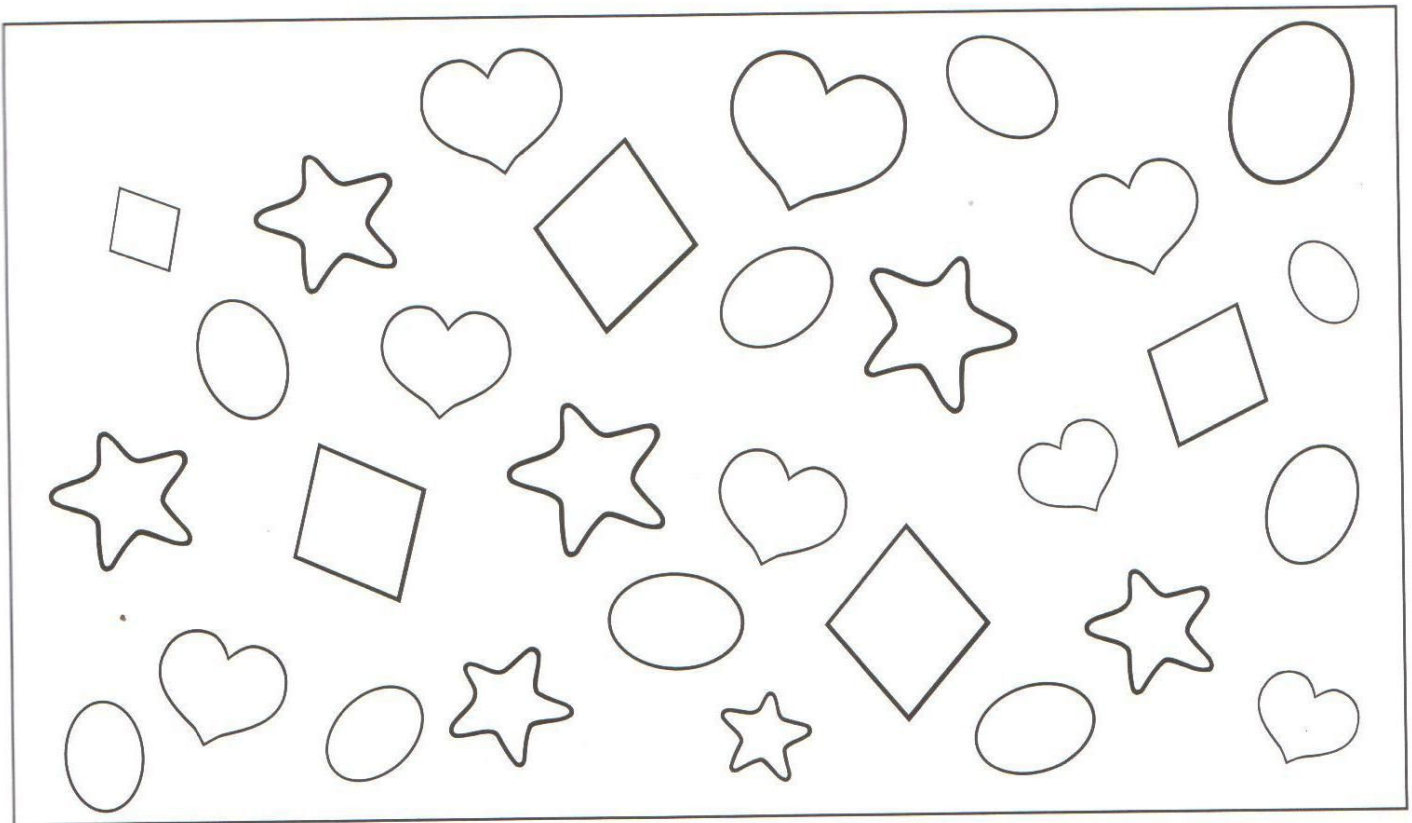

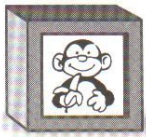

Lesson 16

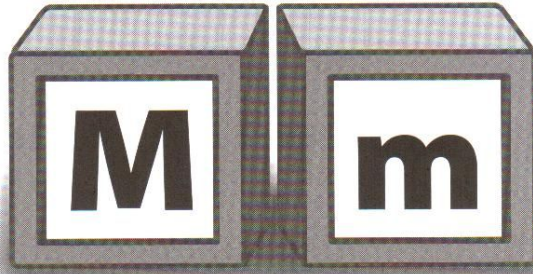

Trace. Write.



Connect. Trace. Color.

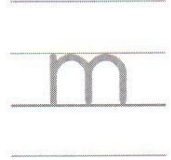
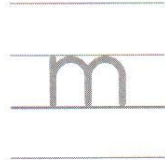
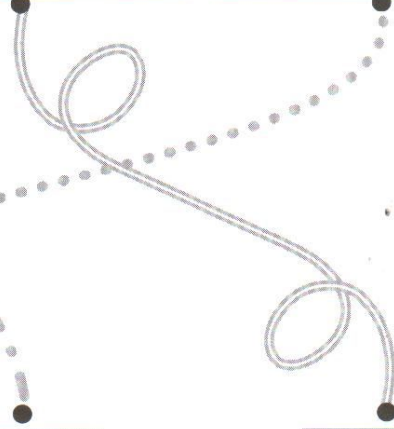
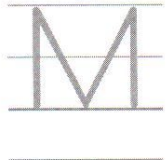
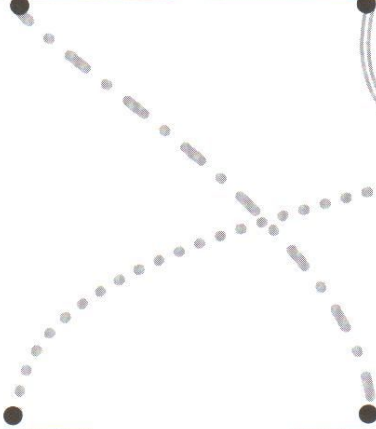
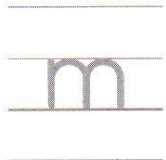
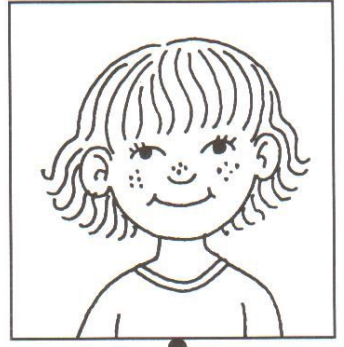
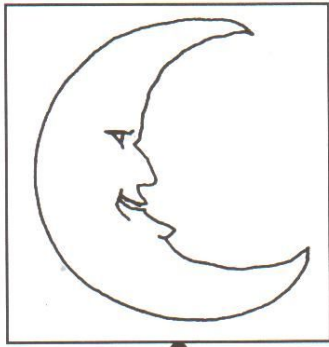
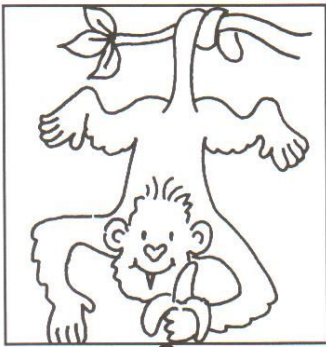

Color.



Match. Color.

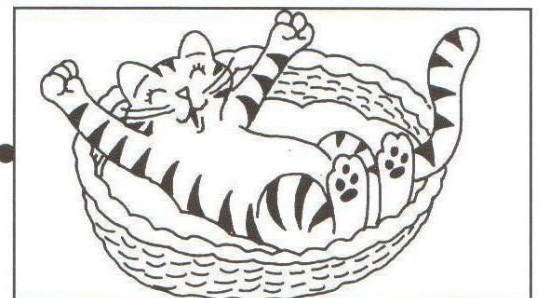
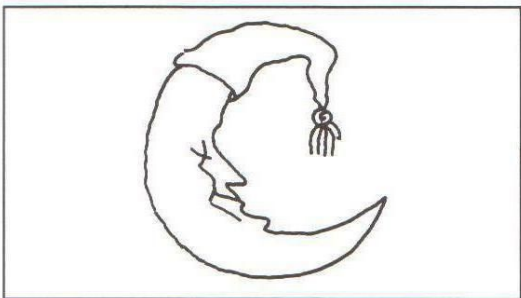
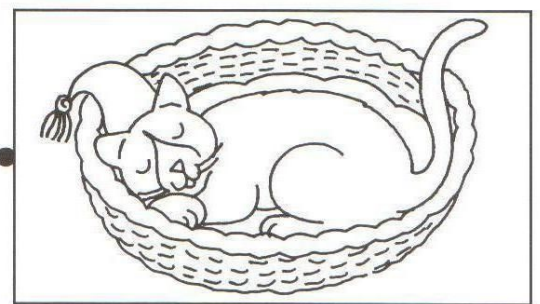
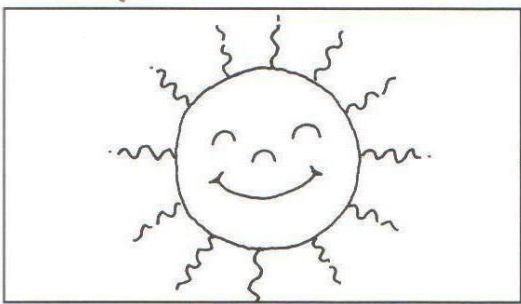

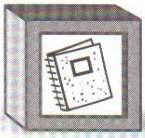

Lesson 17

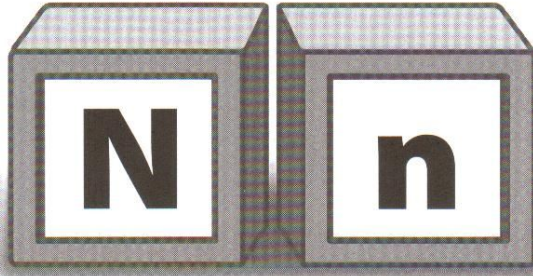

Trace. Write.



Find. Color.

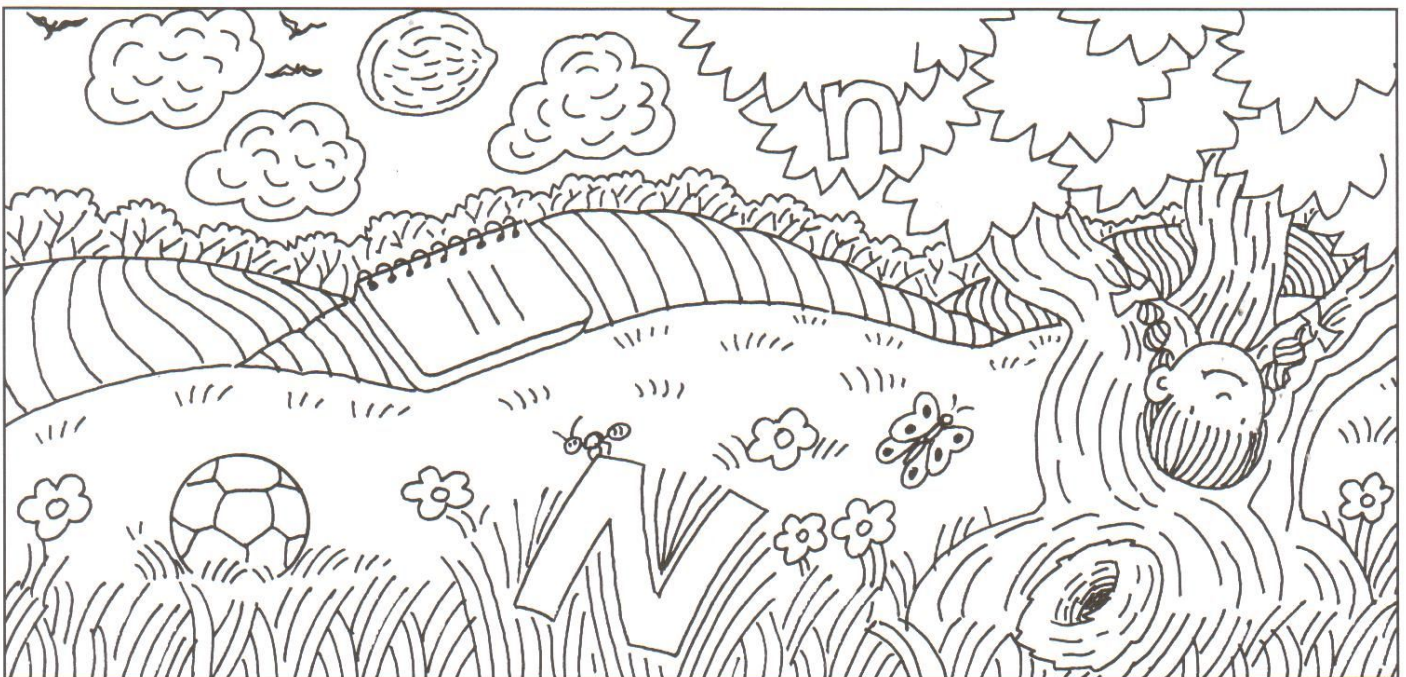
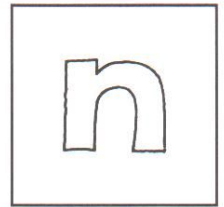
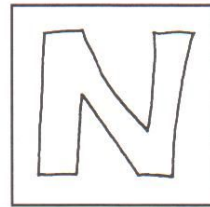
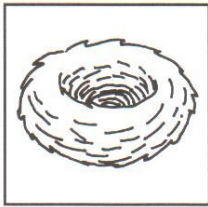
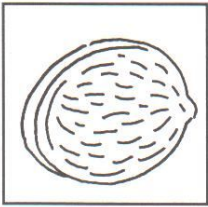

Follow the lines. Color.

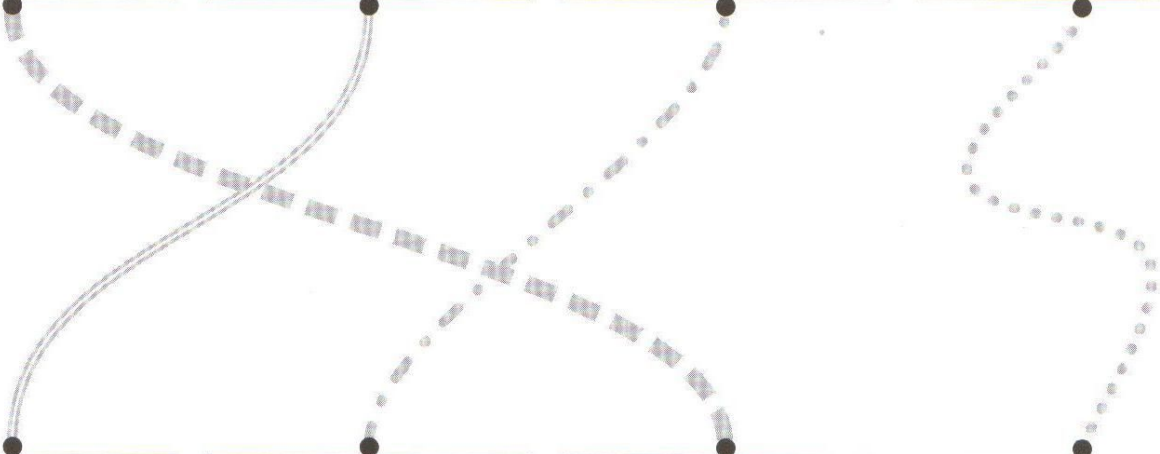
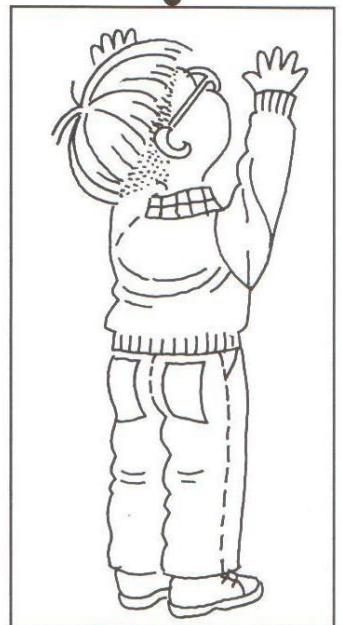
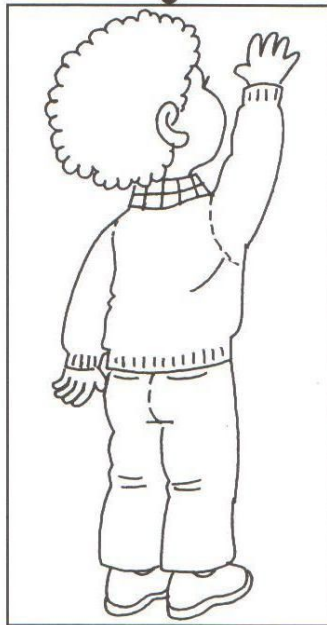
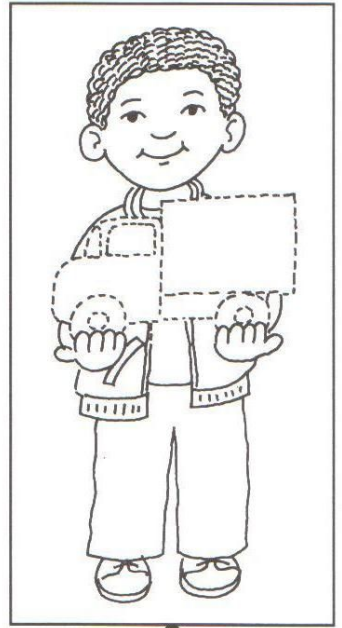



Lesson 18

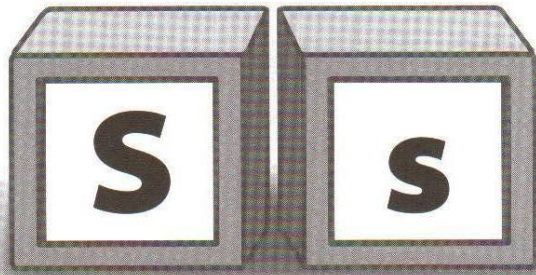

Trace. Write.



Circle the "s" pictures. Color.

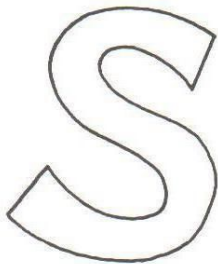
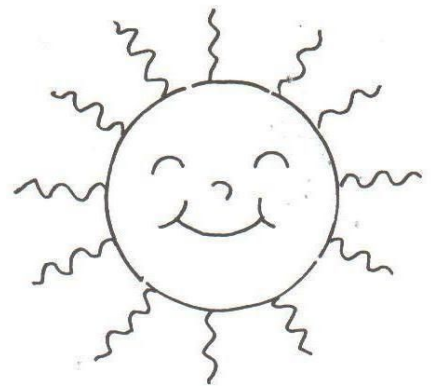
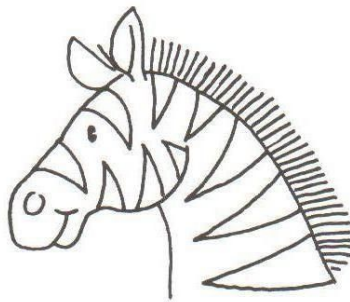
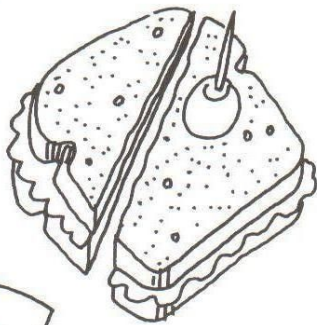
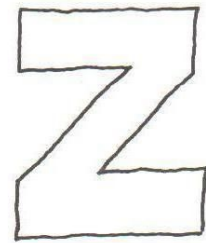
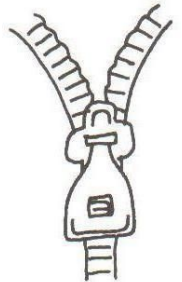
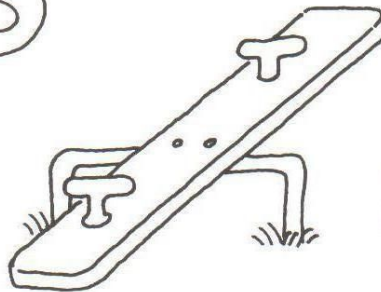
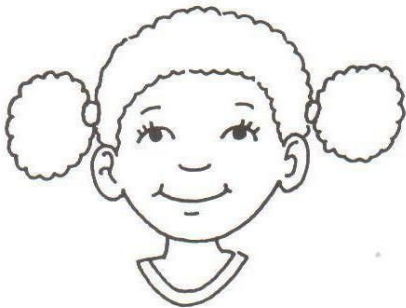

Draw. Trace. Color.

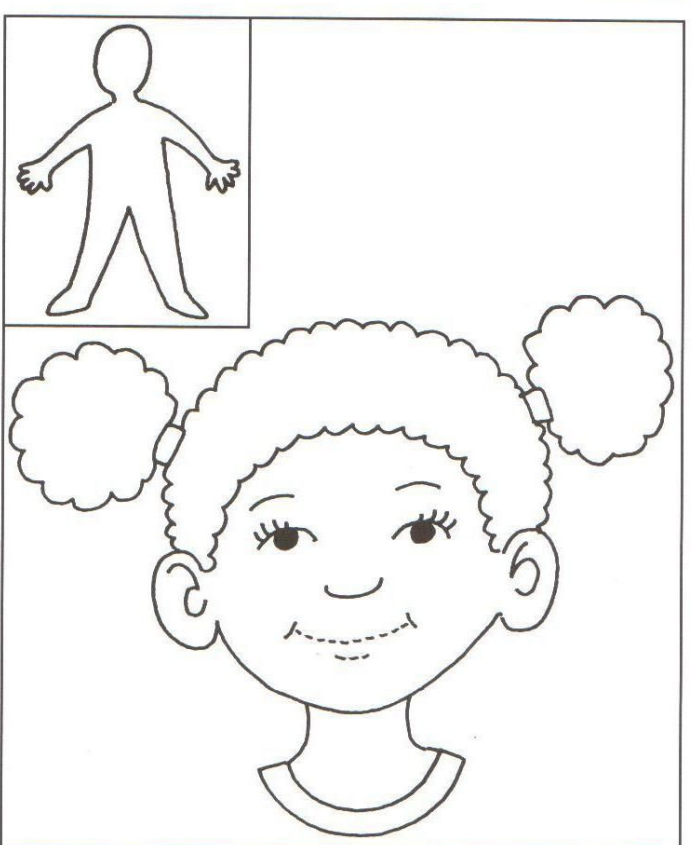
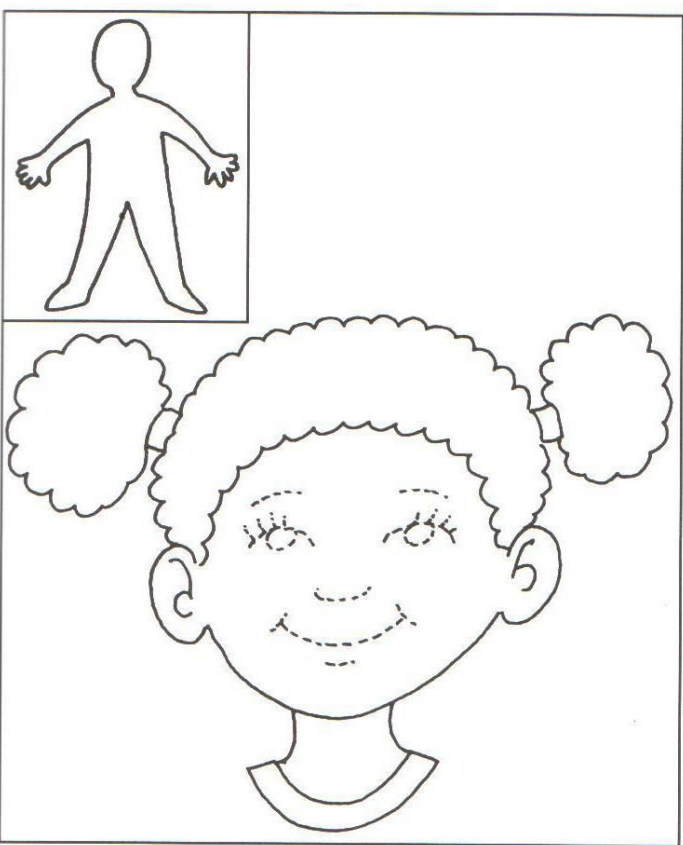
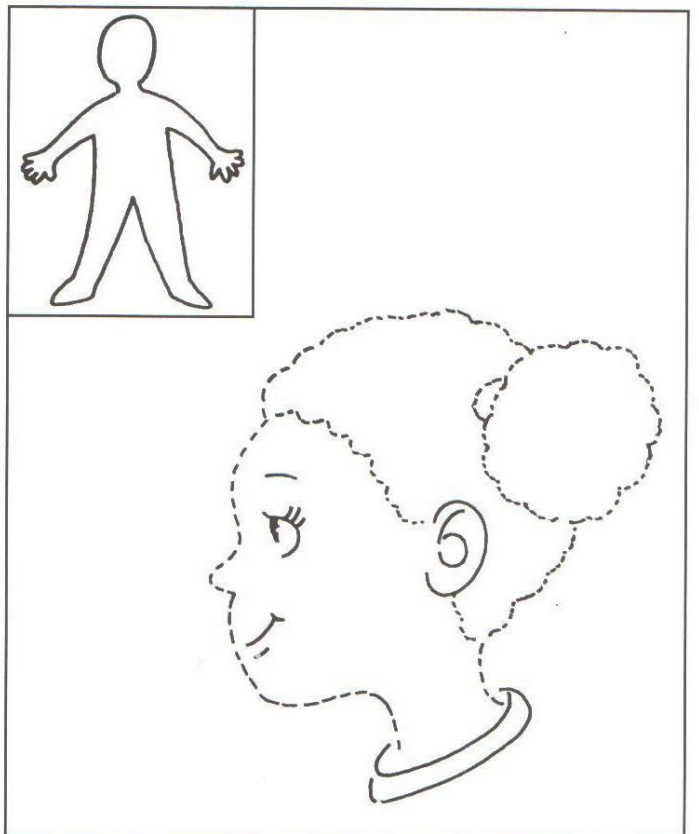



Lesson 19

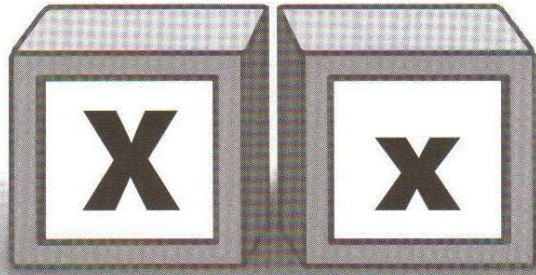

Trace. Write.

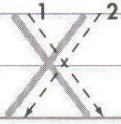

Match. Color.

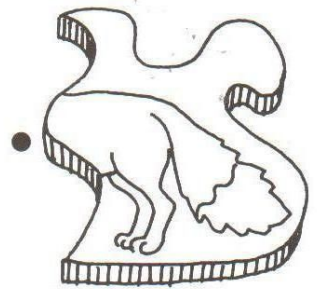
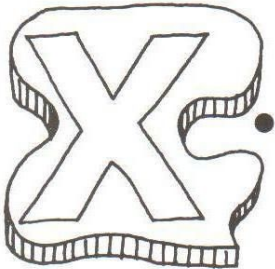
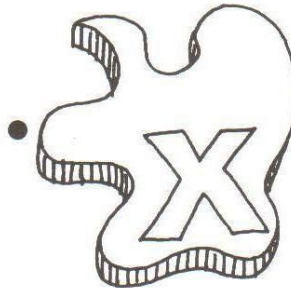
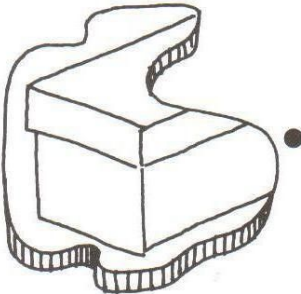
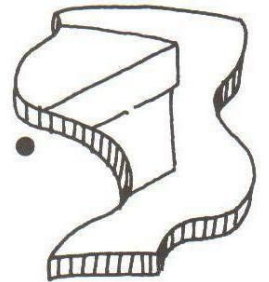
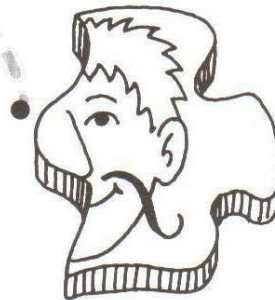
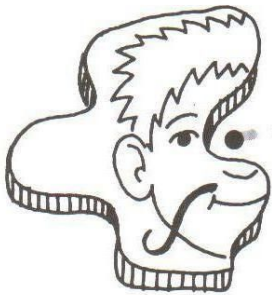

Color.

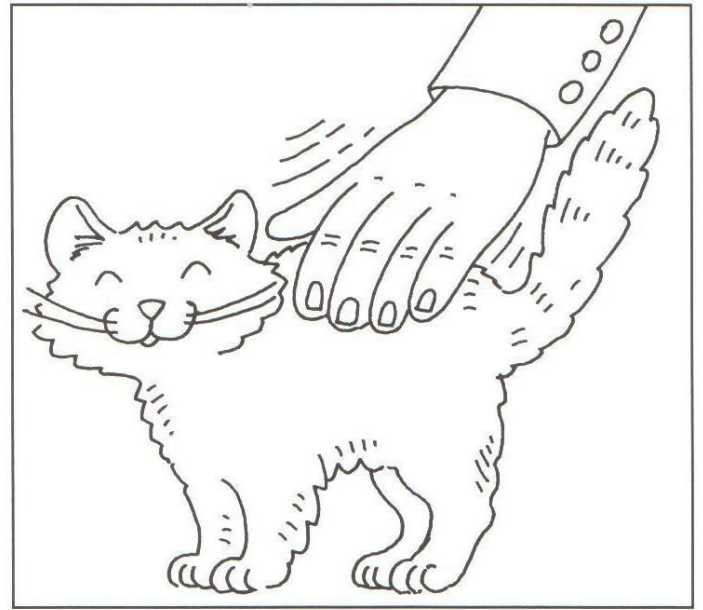
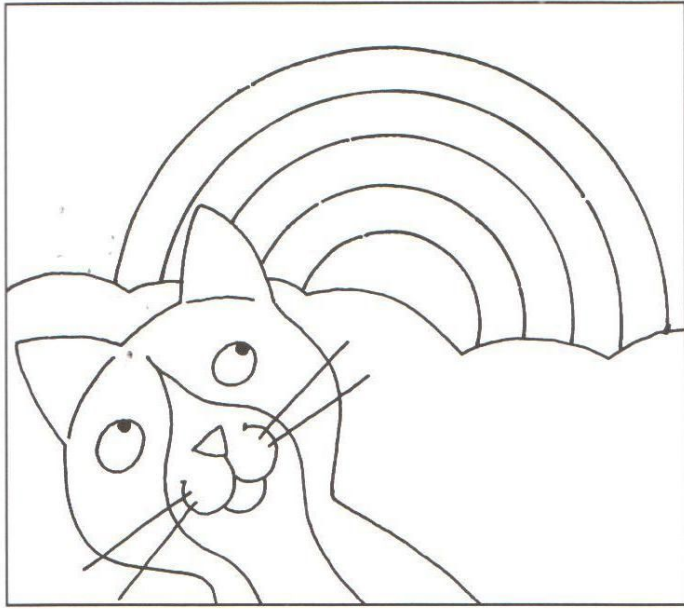

Color.

S L M N F X



Lesson 20

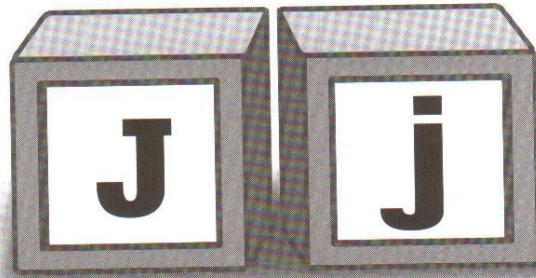

Trace. Write.



Follow. Trace. Color.

A large maze activity for tracing and coloring. The maze starts at a 'START' sign and ends at an airplane labeled 'END'. Inside the maze are illustrations of a boy, a glass of juice, a jar of jam, and a plane. The letters 'J' and 'j' are placed on writing lines within the maze paths.

Connect. Trace. Color.

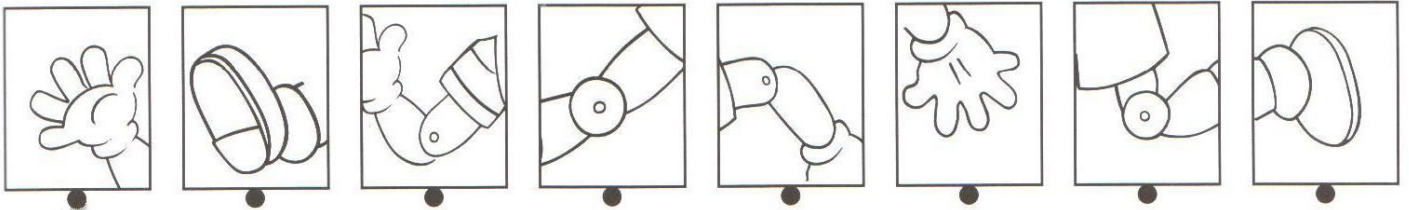



Lesson 21

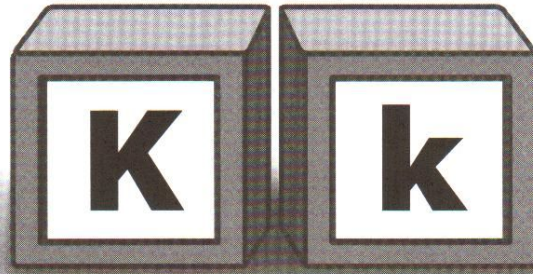

Trace. Write.

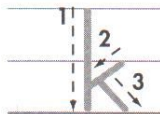
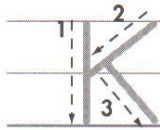

Connect. Trace. Color.

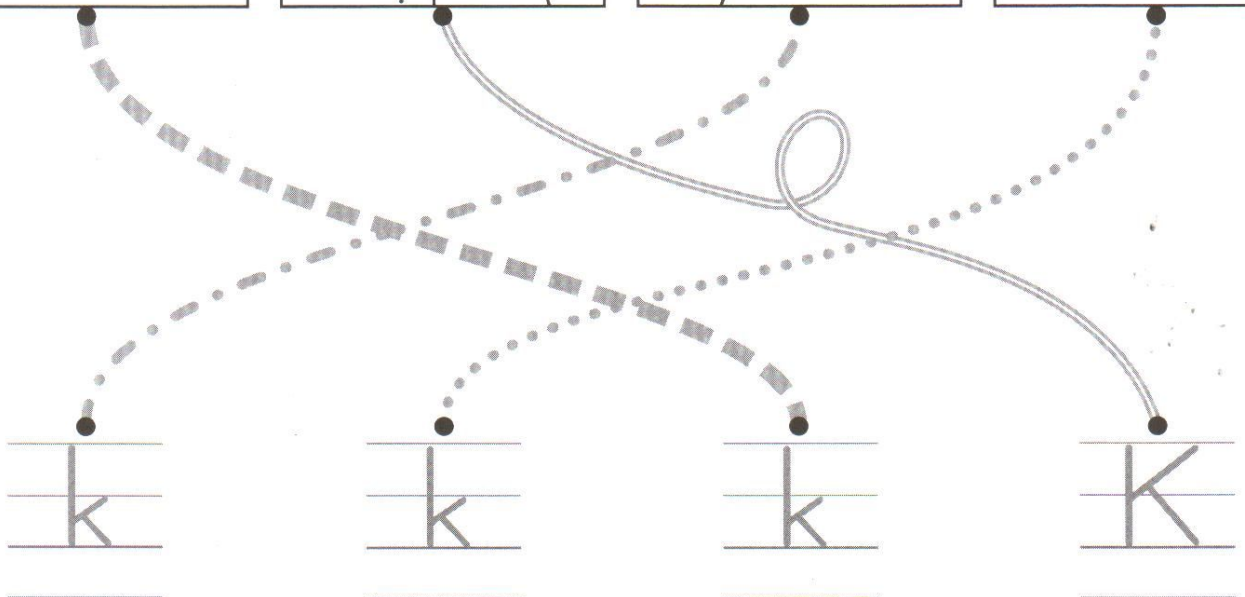
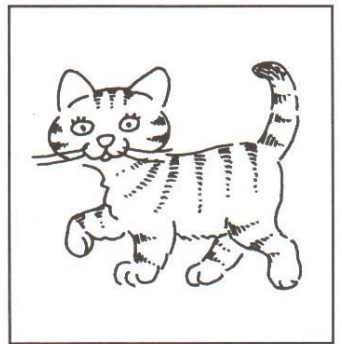
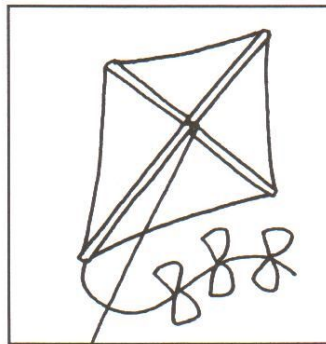
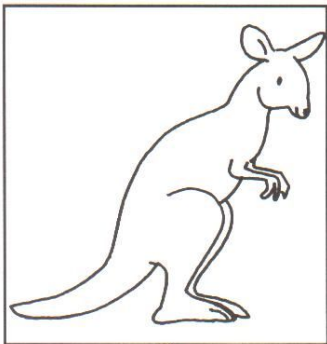

Trace your hand. Color.

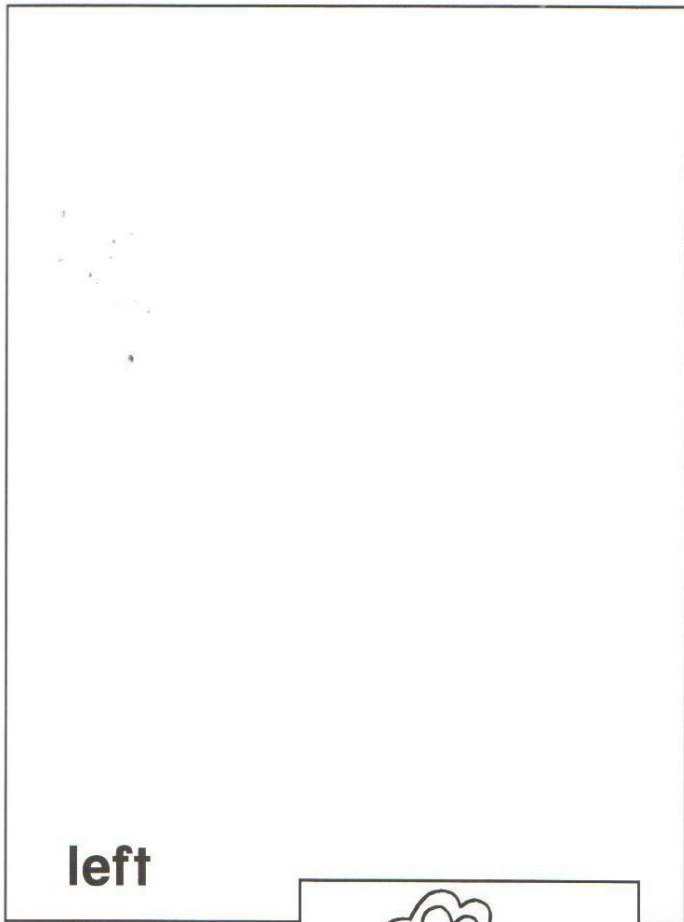

left

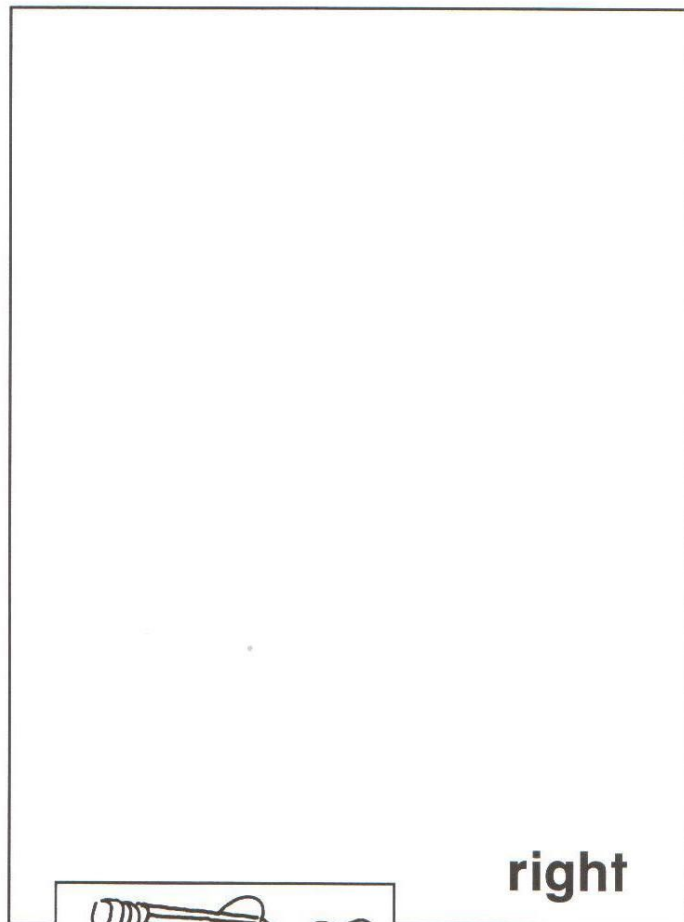

right

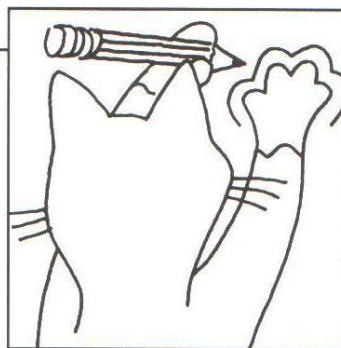
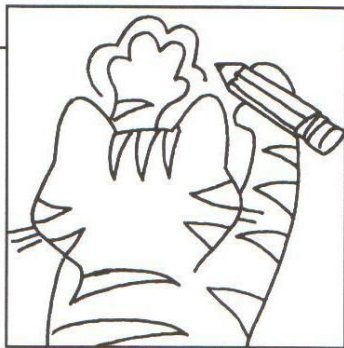

Color.

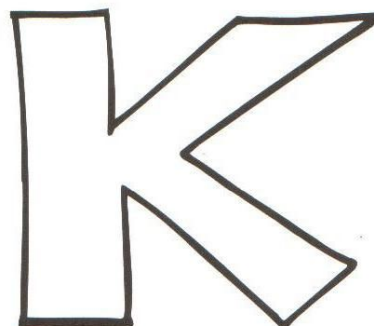
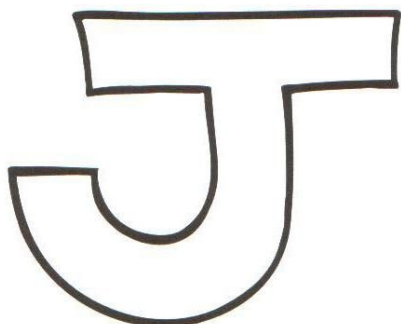



Lesson 22

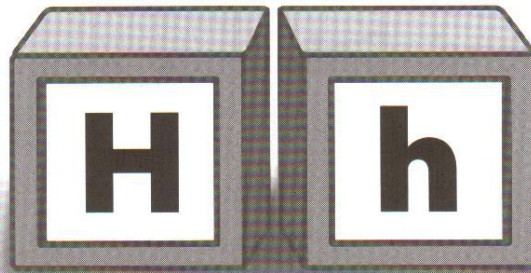

Trace. Write.



Match. Color.

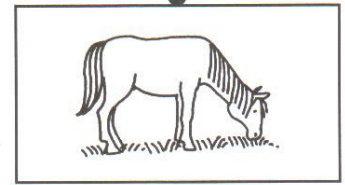
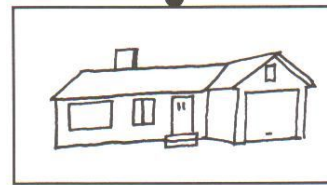
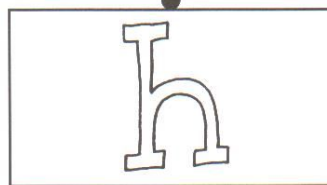
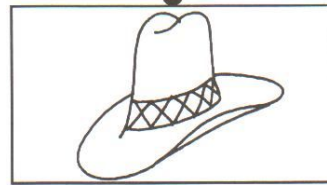
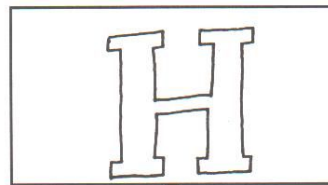
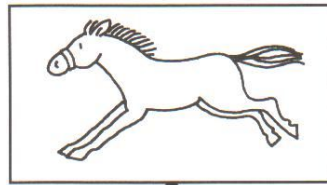
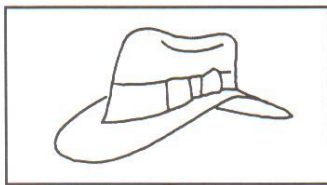

Follow the bee. Color.

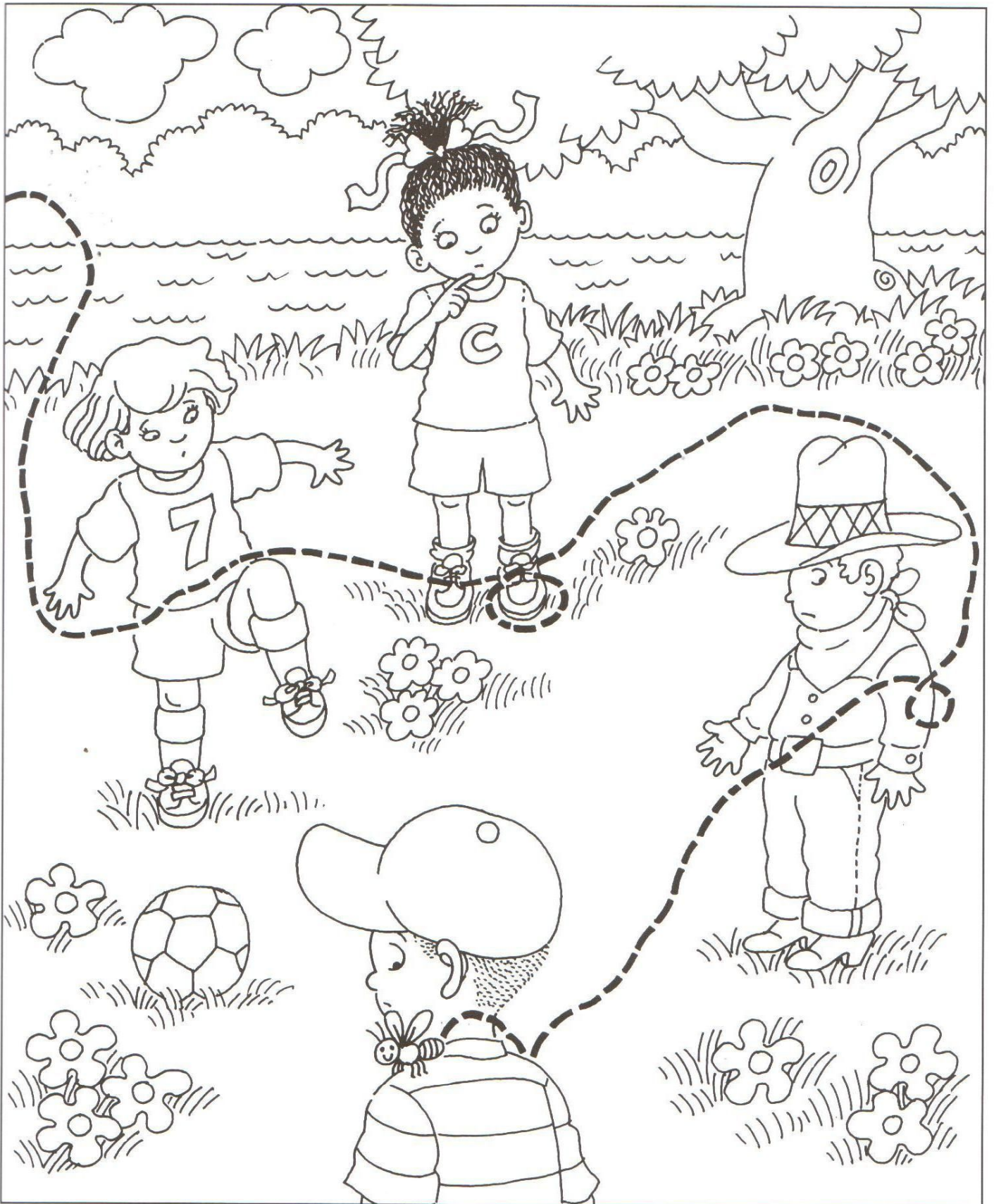



Lesson 23

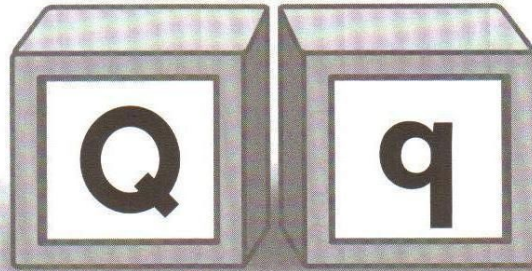

Trace. Write.

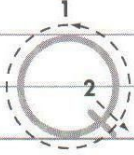

Find. Color.

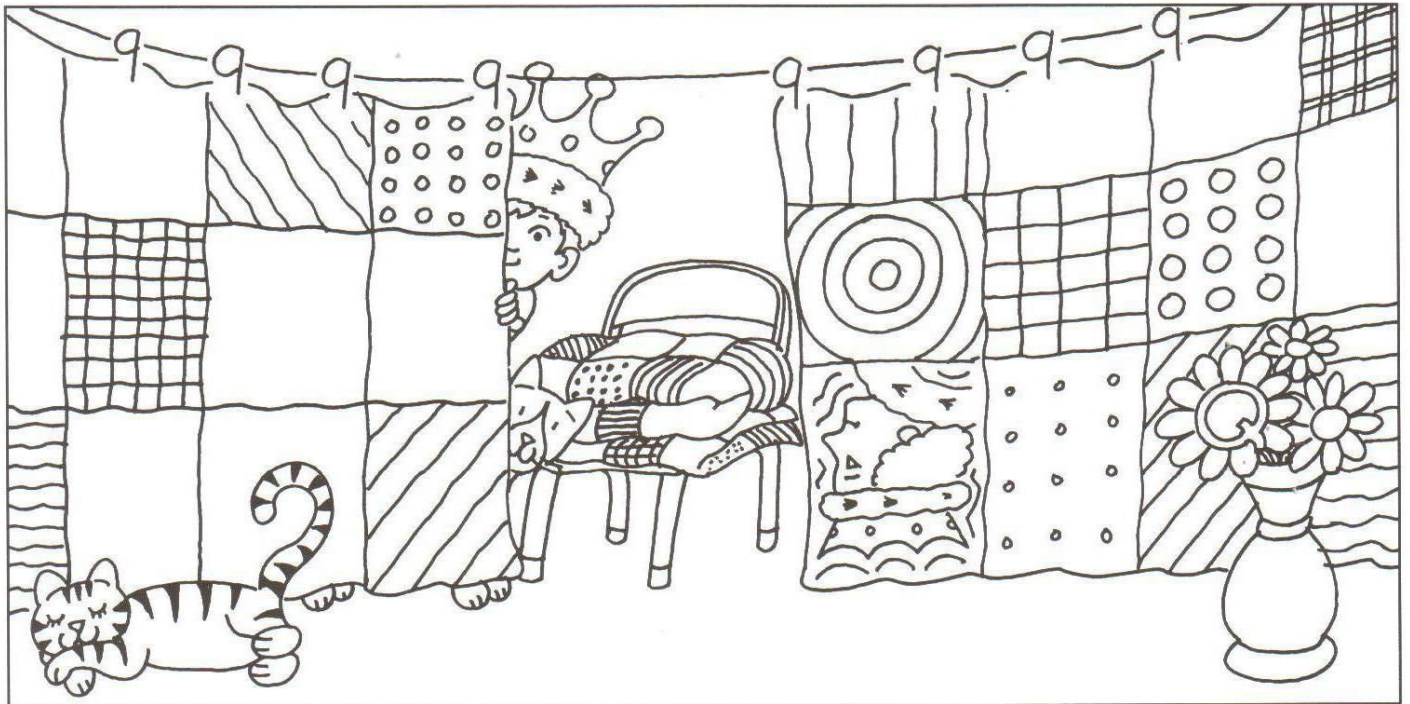
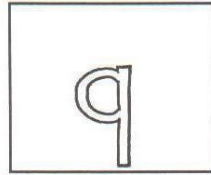
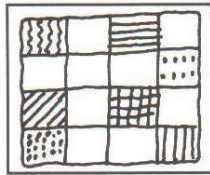

Color.

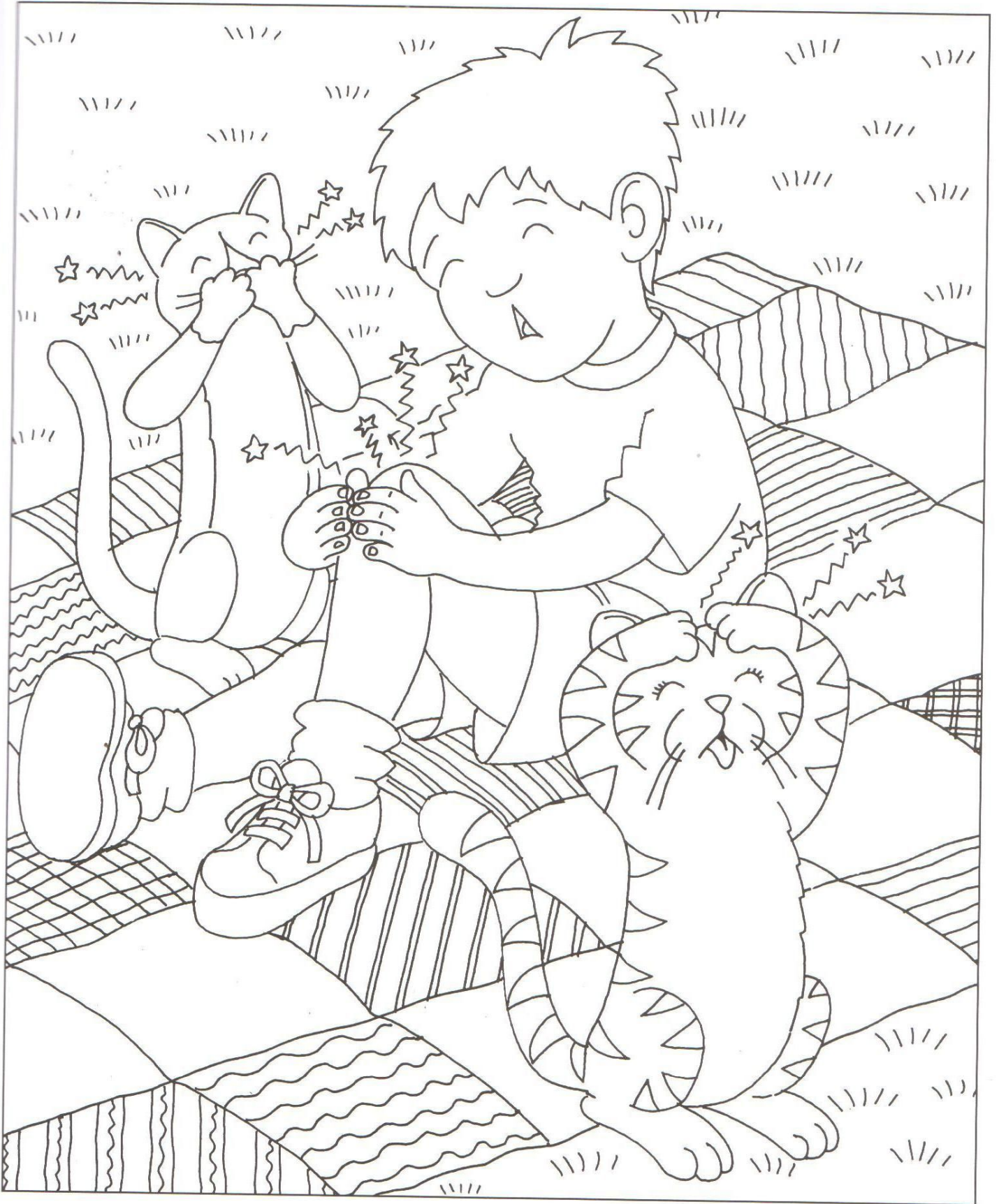

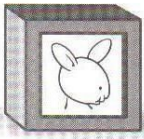

Lesson 24

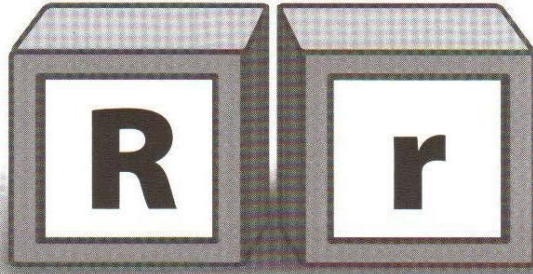

Trace. Write.



Circle the "r" pictures. Color.

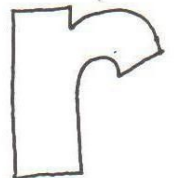
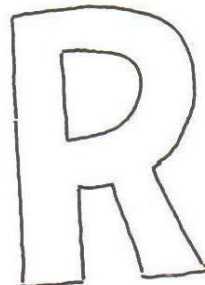
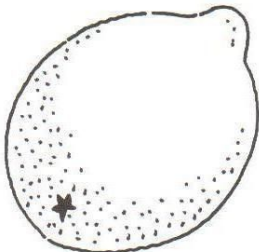
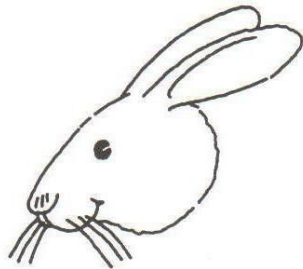
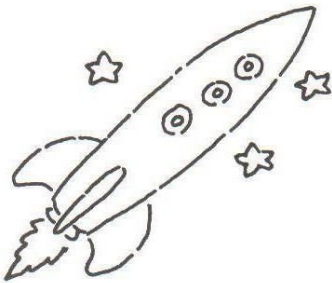

Color.

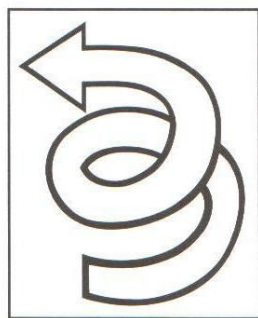
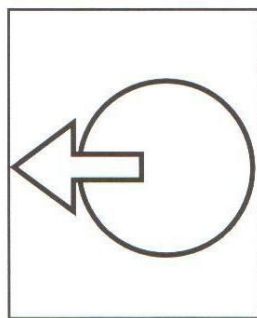
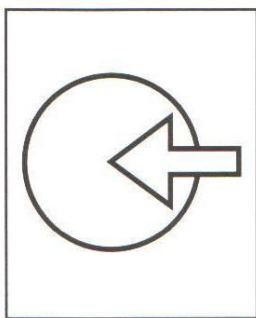
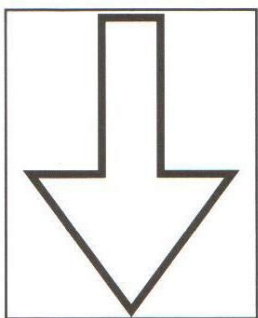
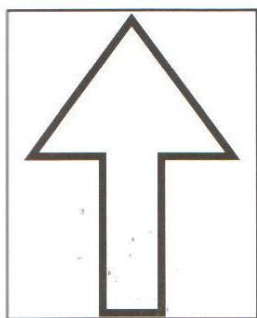

Color.

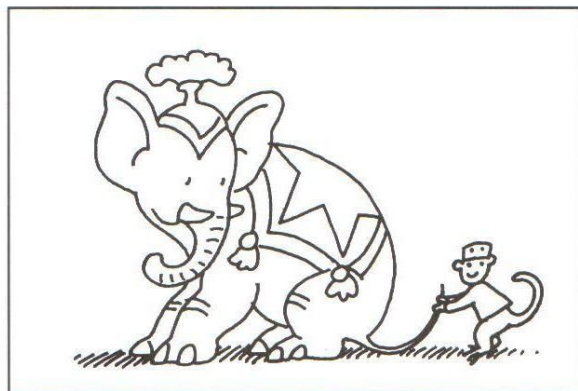
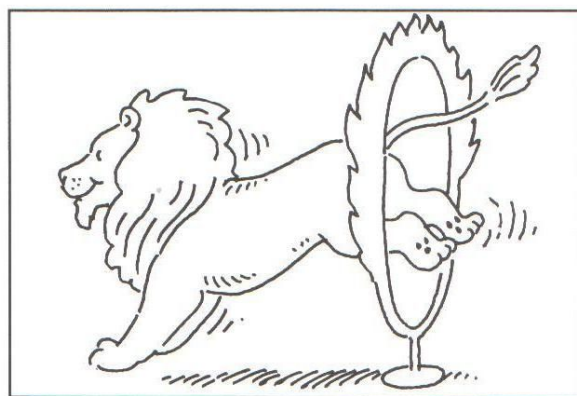
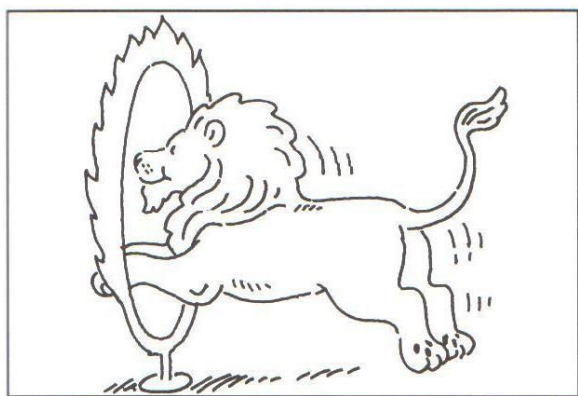



Lesson 25

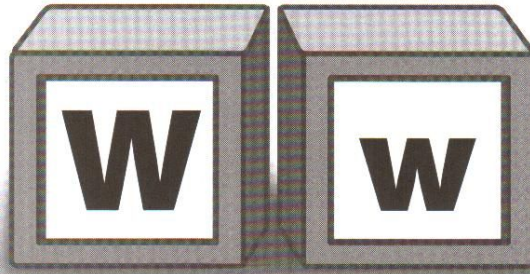

Trace. Write.

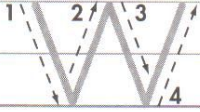

Connect. Trace. Color.

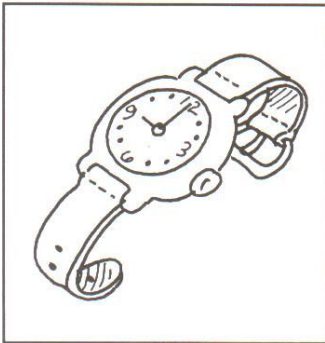

Connections between images and letters:

- Wristwatch (Image 1) connects to the first 'W' (Image 5).
- Girl's face (Image 2) connects to the second 'w' (Image 6).
- Washing hands (Image 3) connects to the third 'W' (Image 7).
- Woman walking (Image 4) connects to the fourth 'W' (Image 8).

Tracing letters on lined paper:

- Image 5: Uppercase 'W' on a line.
- Image 6: Lowercase 'w' on a line.
- Image 7: Uppercase 'W' on a line.
- Image 8: Uppercase 'W' on a line.

Match. Color.

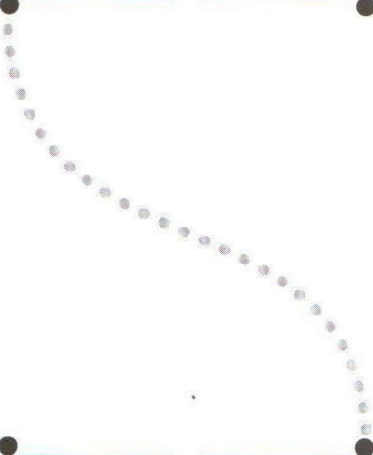

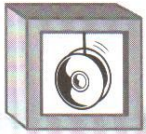

Lesson 26

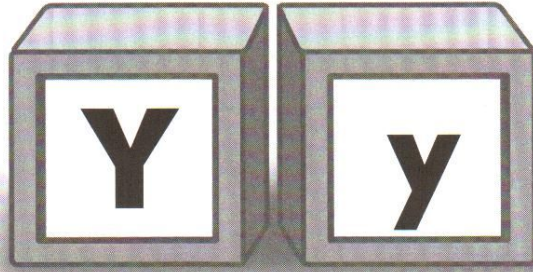

Trace. Write.



Match. Color.

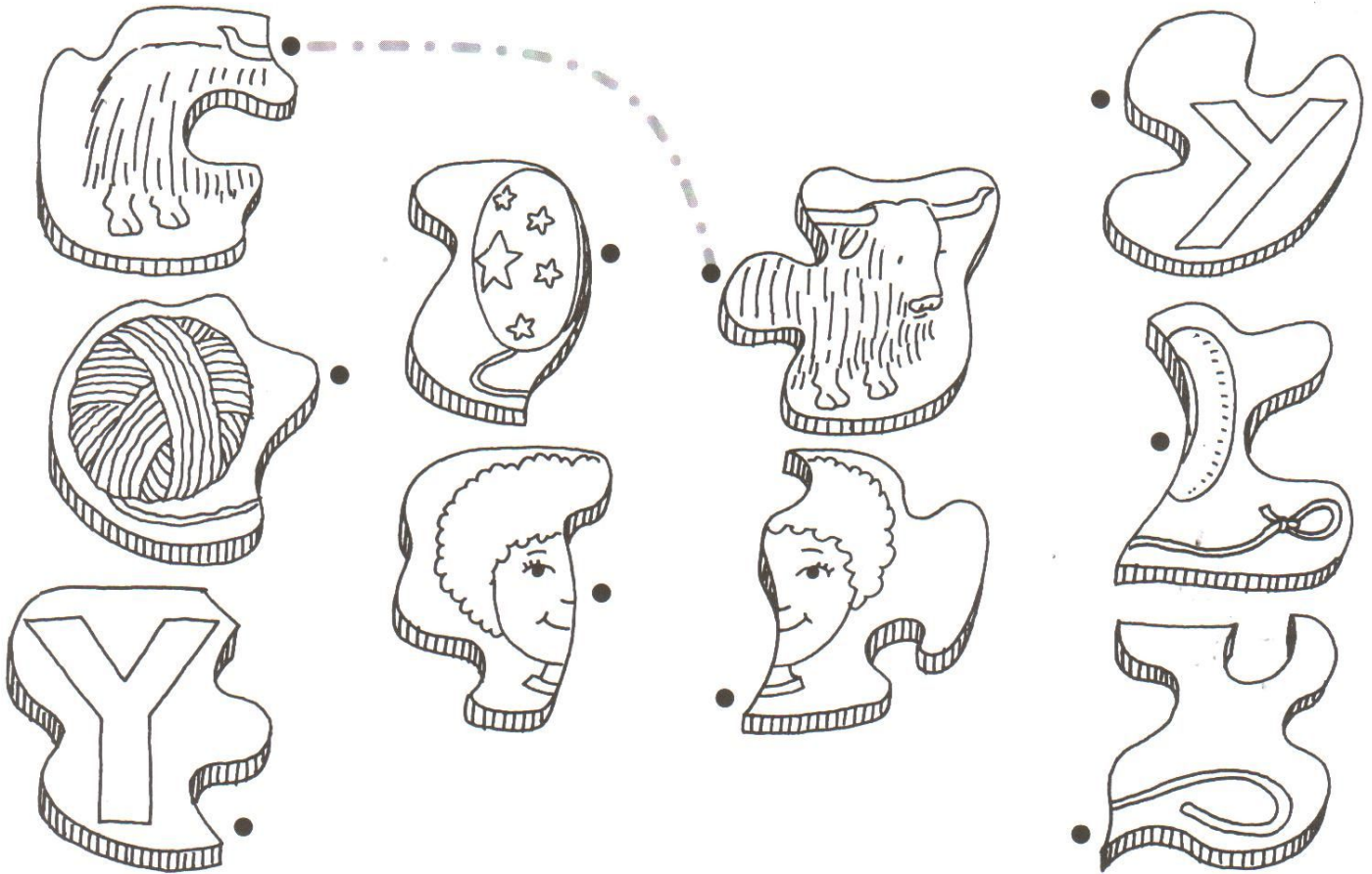

Color.

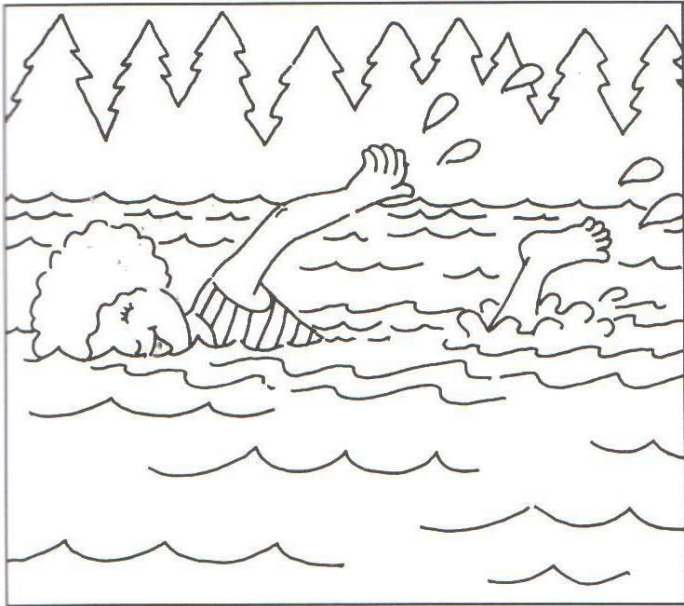

Color.

H Q R W Y

Lesson 27

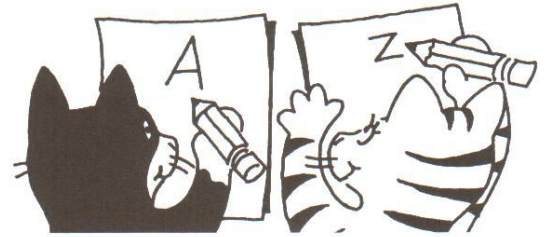

Trace the alphabet.

Tracing practice for the alphabet, showing stroke order for each letter on a four-line grid. The letters are arranged in rows:

- Row 1: A (1: diagonal down-left, 2: diagonal down-right, 3: horizontal bar), B (1: vertical line down, 2: top curve, 3: bottom curve), C (dashed circle), D (1: vertical line down, 2: curve), E (1: vertical line down, 2: top bar, 3: middle bar, 4: bottom bar).
- Row 2: F (1: vertical line down, 2: top bar, 3: middle bar), G (1: counter-clockwise curve, 2: horizontal bar), H (1: left vertical line down, 2: right vertical line down, 3: horizontal bar), I (1: vertical line down, 2: top bar, 3: bottom bar), J (1: horizontal bar, 2: curve down).
- Row 3: K (1: vertical line down, 2: diagonal down-right, 3: diagonal down-left), L (1: vertical line down, 2: horizontal bar), M (1: left vertical line down, 2: diagonal down-right, 3: diagonal down-left, 4: right vertical line down), N (1: left vertical line down, 2: diagonal down-right, 3: right vertical line down), O (dashed circle).
- Row 4: P (1: vertical line down, 2: curve), Q (1: counter-clockwise curve, 2: tail), R (1: vertical line down, 2: curve, 3: diagonal down-right), S (dashed curve), T (1: vertical line down, 2: top bar).
- Row 5: U (dashed curve), V (1: diagonal down-left, 2: diagonal down-right), W (1: diagonal down-left, 2: diagonal down-right, 3: diagonal down-left, 4: diagonal down-right), X (1: diagonal down-right, 2: diagonal down-left), Y (1: diagonal down-left, 2: diagonal down-right, 3: vertical line down).
- Row 6: Z (1: horizontal bar, 2: diagonal down-right, 3: horizontal bar).

Write the alphabet.

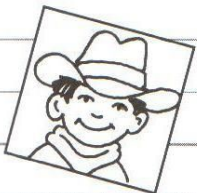

Lesson 28

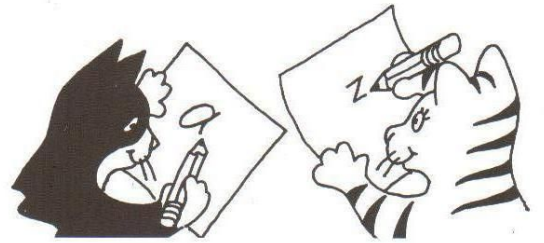

Trace the alphabet.

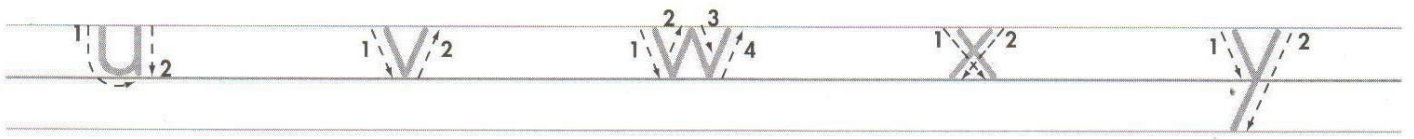
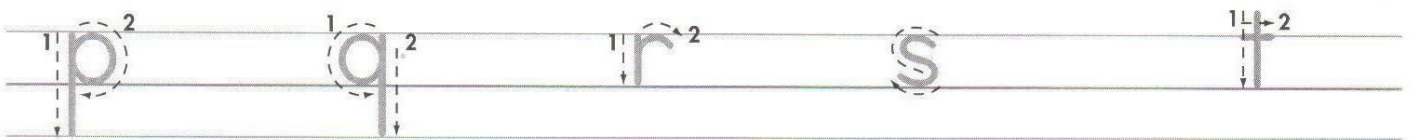
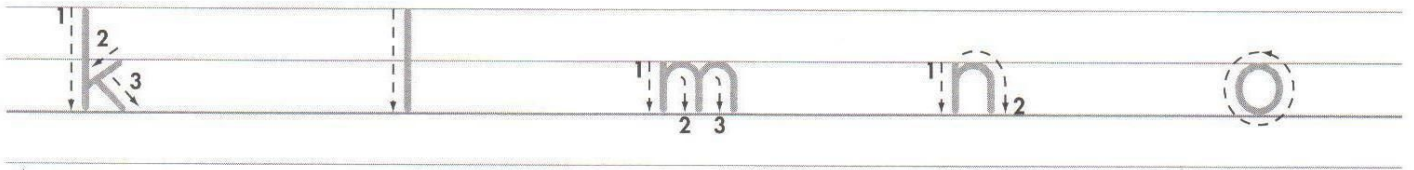
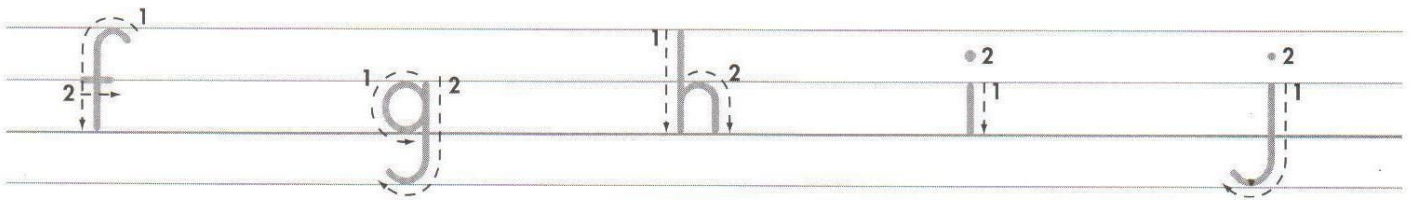
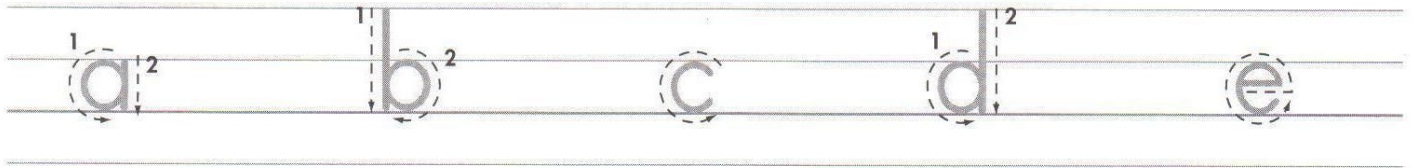

Write the alphabet.

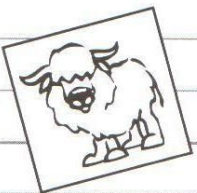
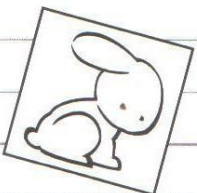
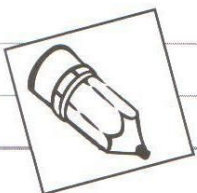
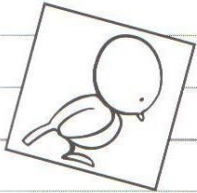

Lesson 29

Write the letter. Draw a picture.

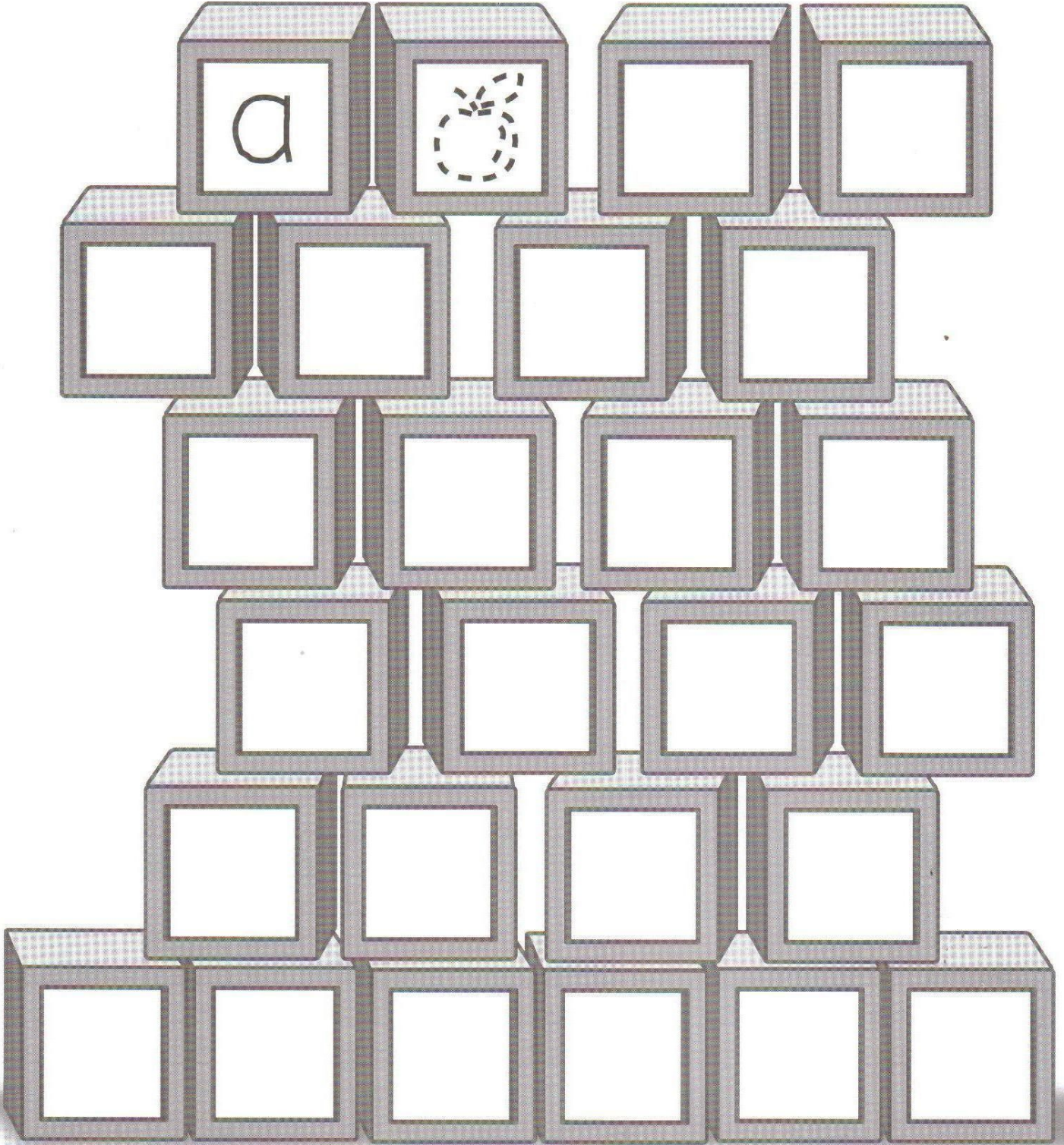

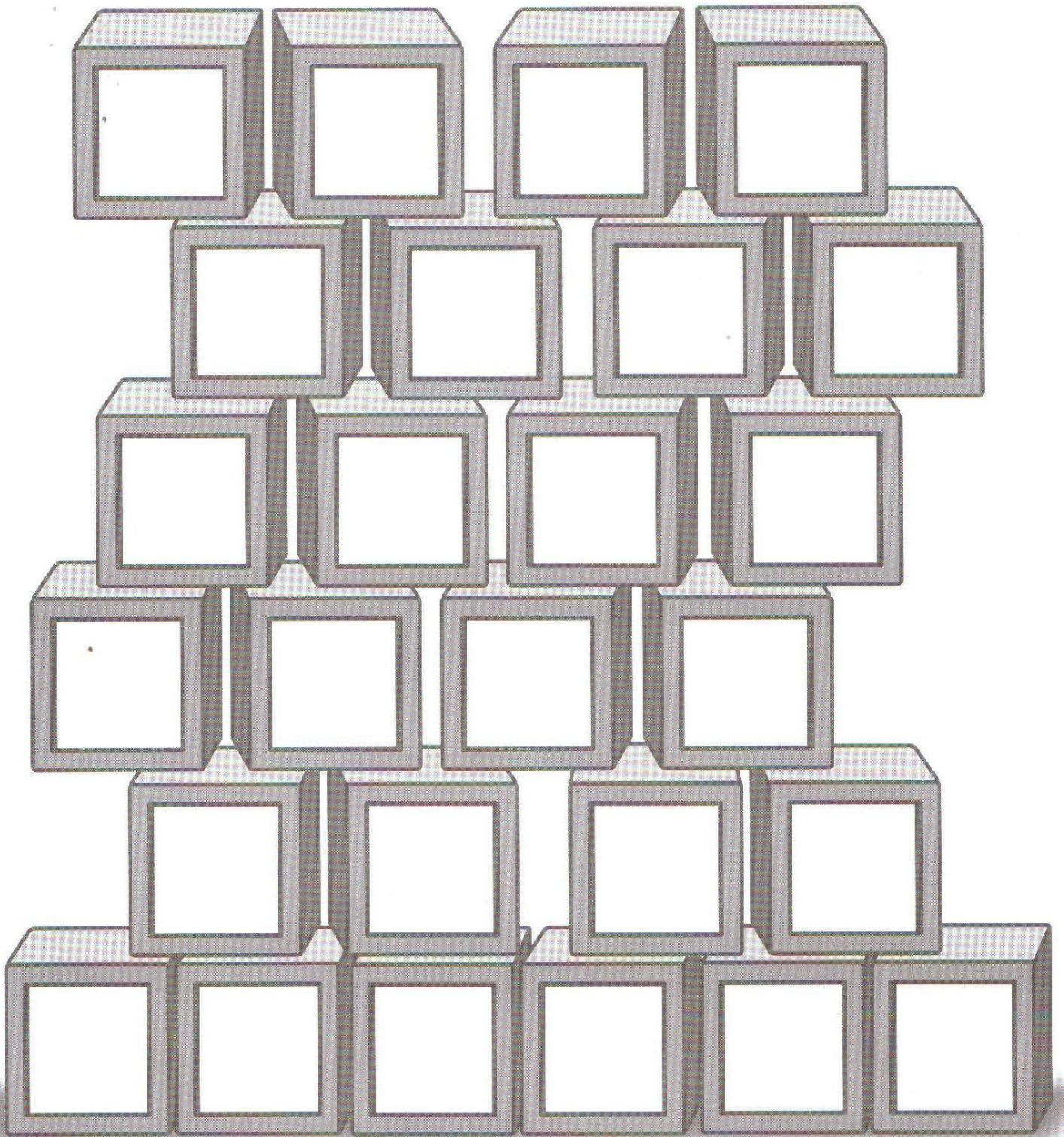

LET'S GO

Let's Go Starter is the introductory level to the *Let's Go* series, a course for children beginning their studies of English. The Starter level presents the alphabet, basic phonics, and simple language structures to preschool and kindergarten children. Each two-page lesson focuses on a letter of the alphabet and an expression or dialogue, and uses songs and chants by Carolyn Graham. Classroom interaction in English is encouraged from the very beginning through a focus on question and answer forms, pairwork, and communicative games.

The Starter level consists of a **Student Book**, an interleaved **Teacher's Book**, a **Workbook**, and a **Cassette**. Additional components include a book of reproducible **Teacher-Made Picture Cards**, **Wall Charts**, an **Audio CD**, **Student Cards**, and full-sized **Teacher's Cards**. The **Student Book**, **Teacher's Book**, and **Wall Charts** are also available in picture editions.

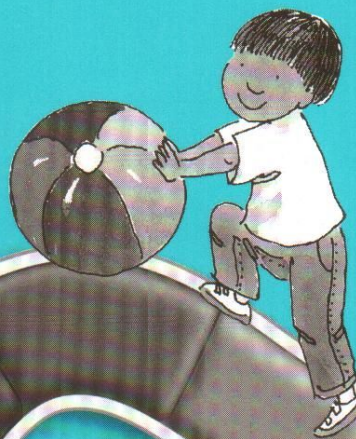

OXFORD
UNIVERSITY PRESS

ISBN 978-0-19-435291-8



9 780194 352918